

Introduction to Drilling- Basic Operations & Tools



- National Oilwell Varco “NOV” overview
- History of oil drilling
- How is drilling planned?
- Drilling Rig- Main components
- Well Types
- Well Profiles and Designs
- Basic drilling tools
 - Drill pipe, drill collars, heavy weights
 - Mud motors
 - Drill Bits
- Typical drilling operations and sequence

- Since 1841, National Oilwell Varco (NOV) has been dedicated to ensuring customers receive the highest quality oilfield products and services
- Leveraging over 1,100 worldwide manufacturing, sales and service centers, National Oilwell Varco supplies customer-focused solutions that best meet the quality, productivity, and environmental requirements of the energy industry.
- National Oilwell Varco is a worldwide leader in providing major mechanical components for land and offshore drilling rigs, complete land drilling and well servicing rigs, tubular inspection and internal tubular coatings, drill string equipment, extensive lifting and handling equipment, and a broad offering of downhole drilling motors, bits and tools.
- National Oilwell Varco also provides supply chain services through its network of distribution service centers located near major drilling and production activity worldwide.

Company Overview

1841: Company Brissonneau Brothers was established.
Later named BLM

63,000

 **NOV**
Employees
Globally

**Global
Presence**

2012

\$ 20.0
Billion
Revenue

Global Presence



- 1185+ facilities worldwide in 61 Countries
- 34 manufacturing locations
- 200+ acquisitions over 12 years

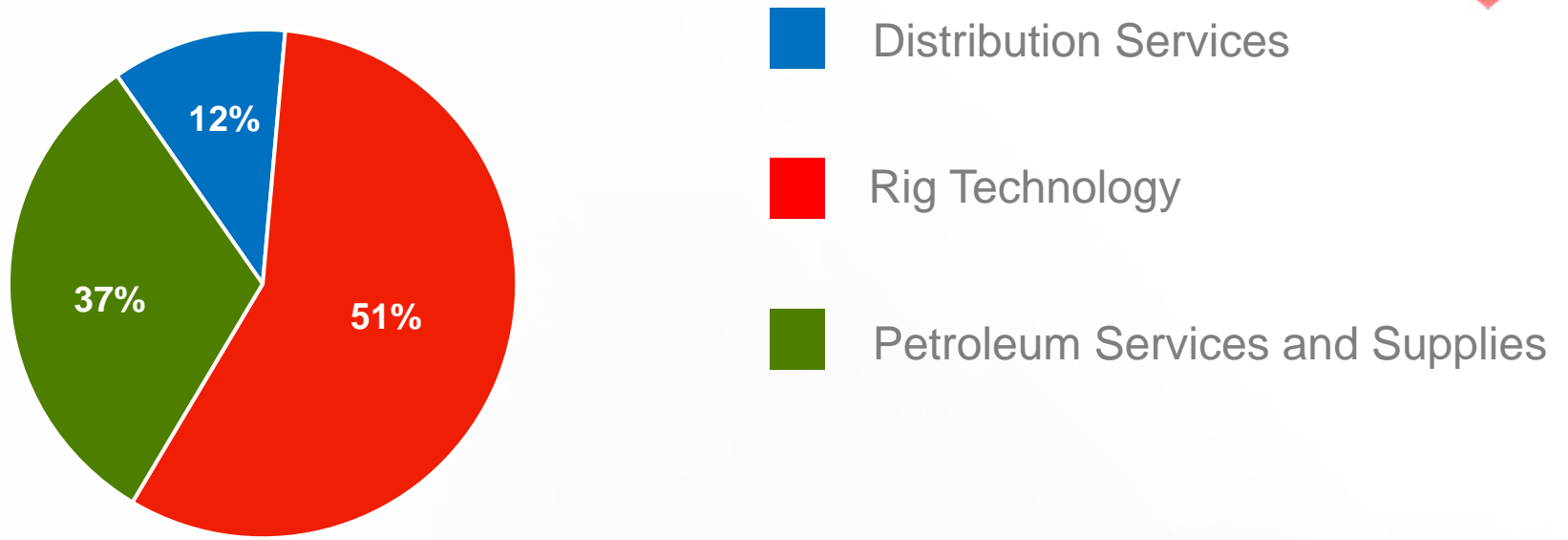

Solution Groups

- Downhole
- Drilling
- Engineering & Project Management
- Lifting & Handling
- Production
- Supply Chain
- Tubular & Corrosion control
- Well Service & Completion

DOWNHOLE

- Asset Inventory Management
- Borehole Enlargement
- Coiled Tubing
- Coiled Tubing Equipment
- Coring Services
- Directional Control Systems
- Drill Bits
- Drill Stem Accessories
- Drilling Motors
- Drill String Telemetry
- Drilling Tools
- Drilling Tubulars and Services
- Fiberglass Pipe
- Fishing Tools
- Intervention and Completion Tools
- Service Equipment
- Steering Tools
- Tool Service and Repair

DRILLING

- Coiled Tubing
- Controls and Instrumentation
- Coring Services
- Cranes
- Downhole Tools and Motors
- Drill bits
- Drill Stem Accessories
- Drilling Fluids
- Drilling Tubulars and Services
- Force and Weight Measurement Tools
- Handling Tools
- High Pressure Pumping
- Hoisting
- Jacking and Skidding
- Motion Compensation
- Mud Processing
- Optimization Solutions
- Pipe Handling
- Portable Power
- Power Generation and Distribution
- Power Tools
- Pressure Control Equipment
- Rigs
- Rotating Equipment
- Solids Controls
- Structures
- Waste Management

ENGINEERING AND PROJECT MANAGEMENT

- Design Engineering
- Equipment Repair/Reconditioning
- HAZOP/HAZID Studies
- Product Training
- Project Management
- Rig-Up/Field Service
- System Repair/Field Engineering

LIFTING AND HANDLING

- AHTS Equipment Packages
- Cable Lay Systems
- Cranes
- Marine Vessel Equipment Packages
- Mooring Systems
- Pipelay Systems
- Winches

PRODUCTION

- Artificial Lift
- Choke Products
- Expendables
- FPSO and FSO Products
- Measurement and Controls Products
- Pumps
- Service and Repair
- Single and Dual Chamber Meter Runs
- Unitized/Fabricated Equipment
- Valves and Gauges

SUPPLY CHAIN

- Asset Inventory Management
- Borehole Enlargement
- Coiled Tubing
- Coiled Tubing Equipment
- Coring Services
- Directional control Systems
- Drill Bits
- Drill Stem Accessories
- Drilling Motors
- Drill String Telemetry
- Drilling Tools
- Drilling Tubulars and Services
- Fiberglass Pipe
- Fishing Tools
- Intervention and Completion Tools
- Service Equipment
- Steering Tools
- Tool Service and Repair

TUBULAR AND CORROSION CONTROL

- Asset Inventory Management
- Borehole Enlargement
- Coiled Tubing
- Coiled Tubing Equipment
- Coring Services
- Directional control Systems
- Drill Bits
- Drill Stem Accessories
- Drilling Motors
- Drill String Telemetry
- Drilling Tools
- Drilling Tubulars and Services
- Fiberglass Pipe
- Fishing Tools
- Intervention and Completion Tools
- Service Equipment
- Steering Tools
- Tool Service and Repair

WELL SERVICE AND COMPLETION

- Asset Inventory Management
- Borehole Enlargement
- Coiled Tubing
- Coiled Tubing Equipment
- Coring Services
- Directional control Systems
- Drill Bits
- Drill Stem Accessories
- Drilling Motors
- Drill String Telemetry
- Drilling Tools
- Drilling Tubulars and Services
- Fiberglass Pipe
- Fishing Tools
- Intervention and Completion Tools
- Service Equipment
- Steering Tools
- Tool Service and Repair



Company Overview

Solution Groups

Innovative Technology



History of oil well drilling

- First use of oil (1000+ yrs. ago) was for lighting purposes
- Oil was known to exist but extraction was the issue
- Edwin Drake, hired by Seneca Oil Co. to study potential oil deposits in Titusville, PA. Drilling started in summer 1859
- Well was dug on an island on the oil Creek (Allegheny river)
 - Drilled in the manner as salt well
 - Cable Tool drilling
 - Steam engine to power the drill
 - Progress was about 3 feet/ day
- On August 27, depth was 69.5 ft.
 - Billy Smith (driller) saw oil rising up
 - 25 Bbls of oil were collected in a bath tub on day 1
- The Drake well became the 1st successful oil well



- Drake pioneered a new drilling method for producing oil
 - Using piping to prevent borehole collapse, allowing for the drill to penetrate further into the ground
 - A 32' iron pipe was driven into the bedrock
 - The principle is still employed today
- Drake's method were imitated by others along Oil Creek
 - Several oil boom towns along the creek were born
- Drake's well produced 25 barrels (4.0 m³) of oil a day
 - 1872, the area produced 15.9K BOPD (2,530 m³)
- Drake did not possess good business acumen. He failed to patent his invention. Lost all of his savings in oil (1863)
- He died on November 9, 1880 in Bethlehem, PA

First Producer Wells



Overproduction became an issue
Market was over flooded and price
dropped from few \$ to 10 cts a barrel



1) Phillips well: 4K BOPD , Oct. 1861
2) Woodford well: 1500 BOPD, July 1862
Empire well: 3000 BOPD, Sept. 1861

- Oil replaced most other fuels for mobile use
- Automobile industry, developed by end of 19th century, adopted it as fuel
- Gas engines were designed for successful aircrafts
- Ships driven by oil moved 2x as fast as those coal fired
 - A vital military advantage
- Initially gas was burned off or left in the ground
- By end of WWII (1945) natural gas boomed leveraged on pipe, welding & metallurgical advances
- Petrochemical industry (new plastic materials) followed

- Oil is produced in almost every part of the world
- Well Types: single to multi-boreholes
- Production
 - Few bbls. to large several K thousands bbls/day
- Cost
 - Cheap (<\$1.0m land wells) to expensive (\$100 bn.) offshore developments
- Drilling environments
 - Shallow 20m to deep +3000m reservoirs
 - Water depth of +3,000m
- Reservoir rock type
 - Mainly conventional sedimentary (sand & limestone)
 - Non-conventional (shale)
 - Others
 - Igneous
 - Granite
 - Fractured basement



How is drilling planned?

- Finding o & g is not an easy task- Mother nature always surprises us
- Subsurface geology can be quite complex and difficult to predict

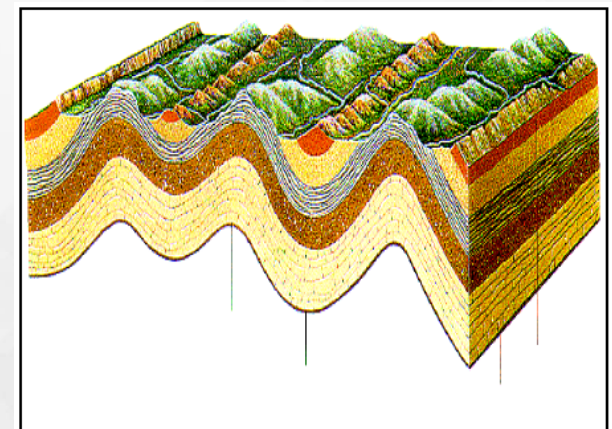
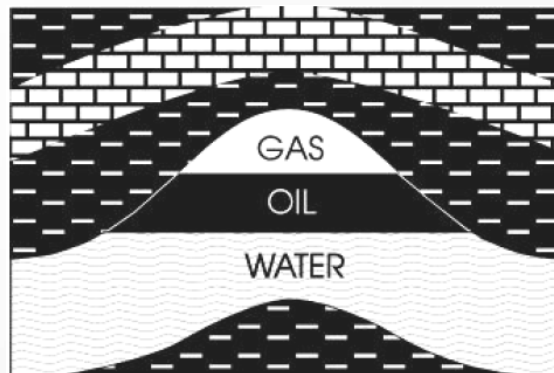
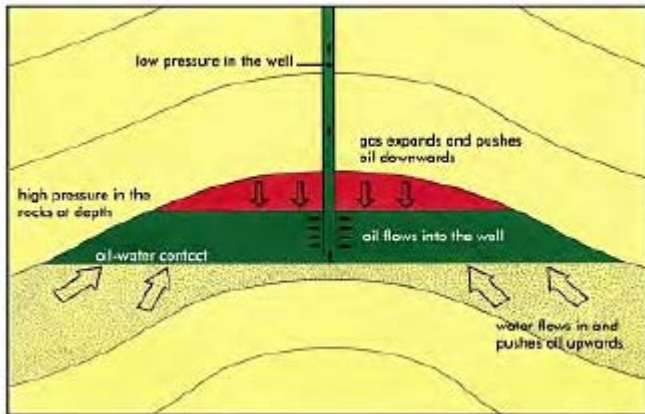

How is drilling planned?

- After a deposit is identified by seismic & advanced 3D visualization techniques, exploration (wildcats) are planned

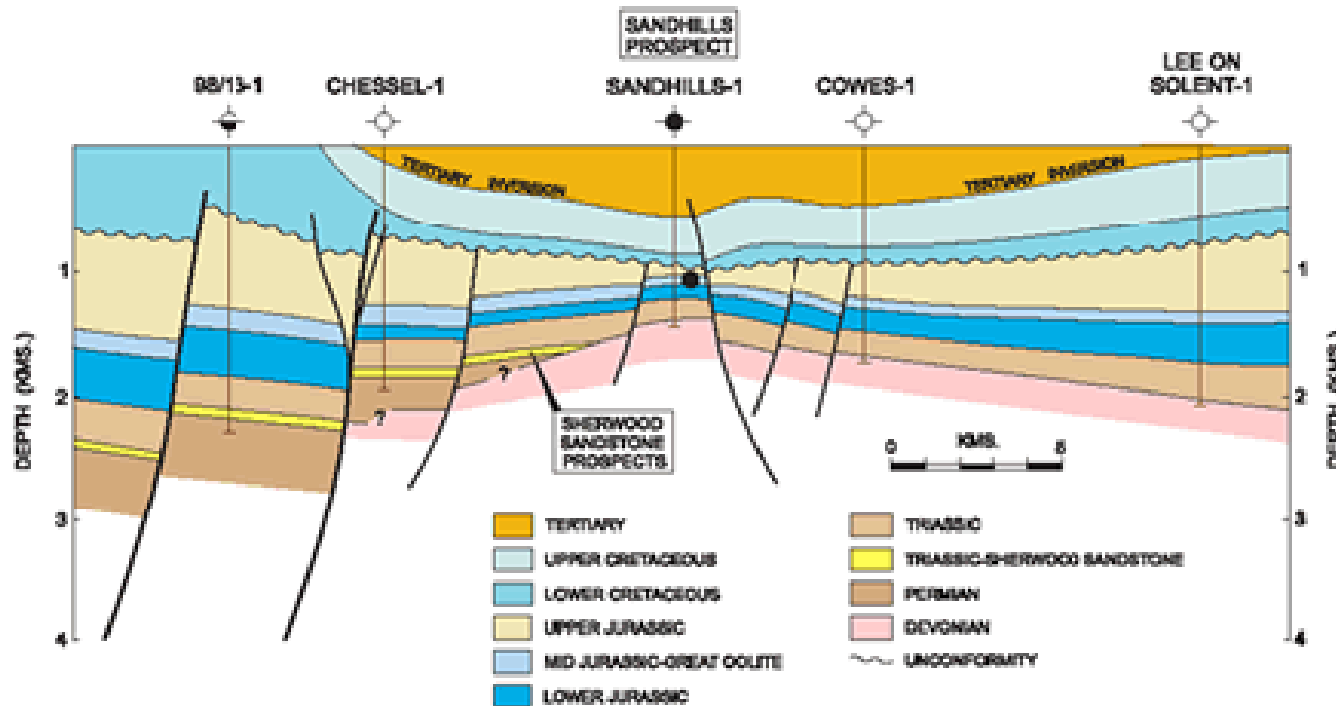

- Final depth, hole/ casing size define specifications and requirements of the drilling rig

A Rig, the drilling machine

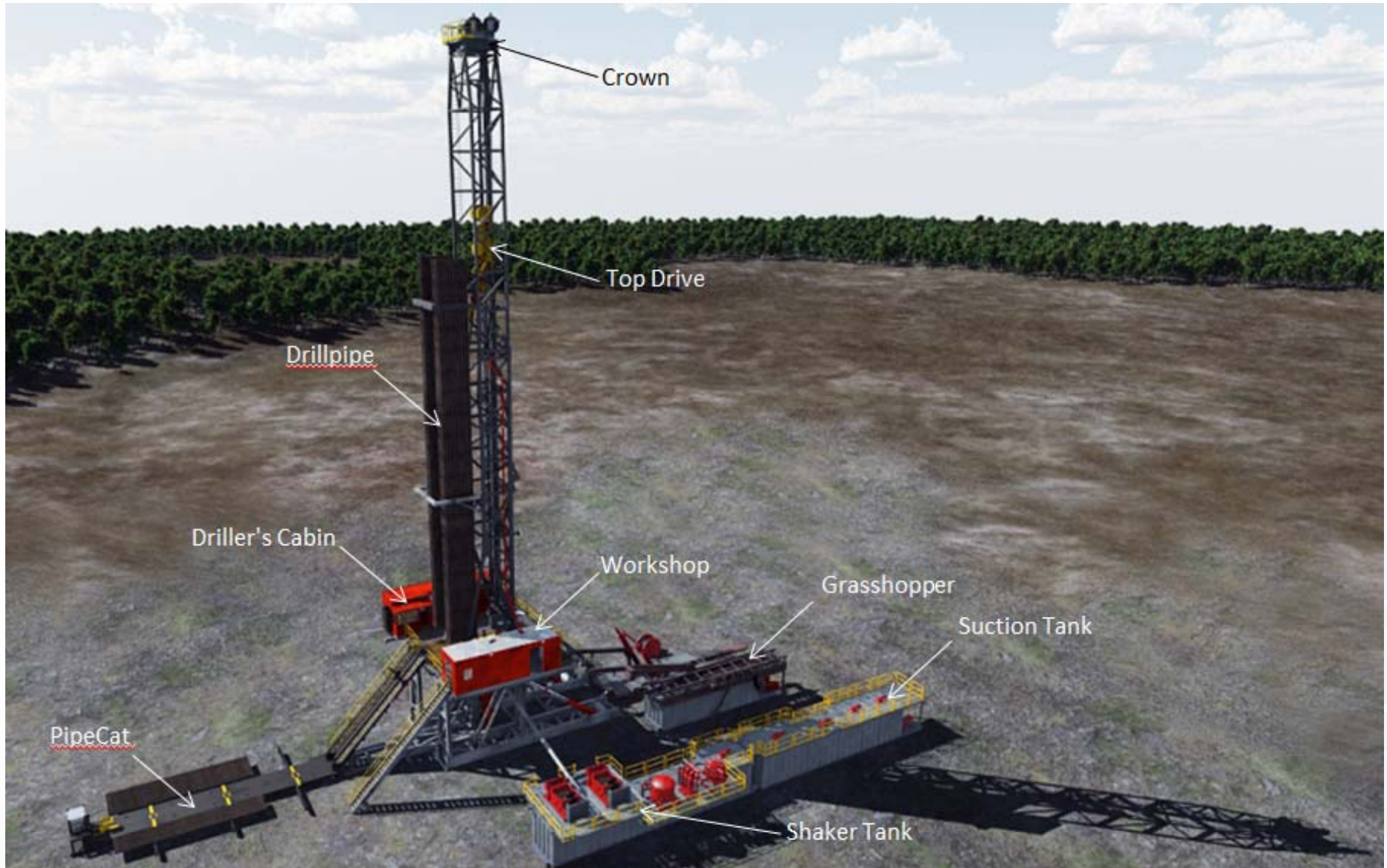

A Rig, the drilling machine



Main Rig Components-1

- Rotary System: Provides the rotation “RPM’s” (via a rotary table or top drive) to turn the entire drillstring and drill bit

It has a beveled gear arrangement to create the rotational motion and opening into which bushings are fitted to drive and support the drilling assembly.



Rotary Table



Main Rig Components-1

- Rotary System: Provides the rotation “RPM’s” (via a rotary table or top drive) to turn the entire drillstring and drill bit

Topdrive

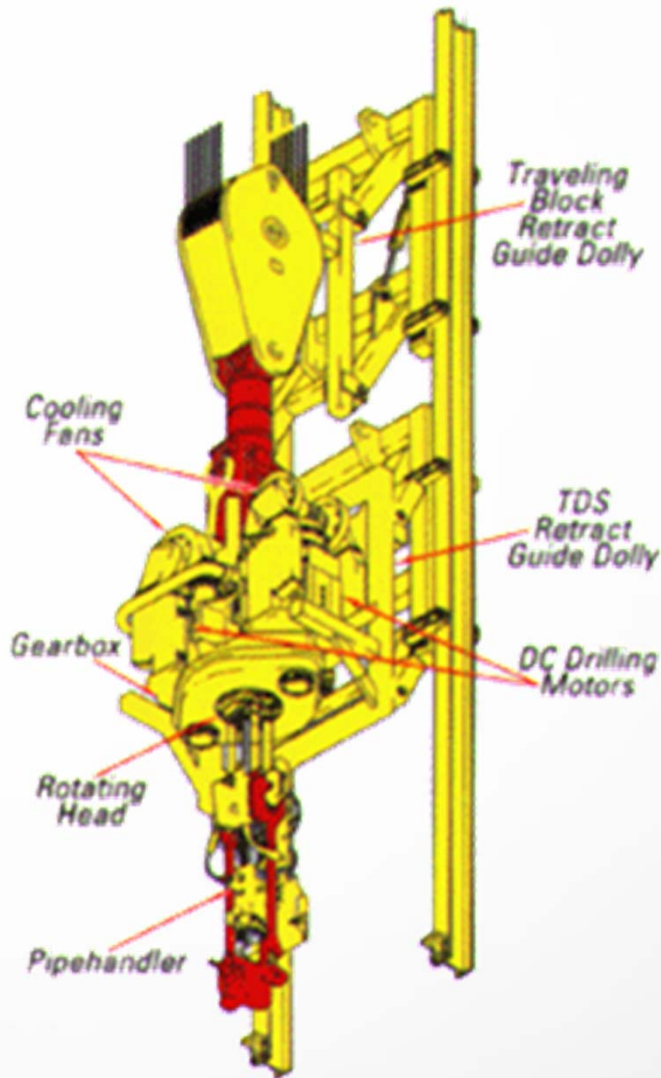

Main Rig Components-2

- Circulating system: Delivers the hydraulic power (HHP) req'd to pump/ move the drilling fluid from surface tanks (pits), through the drillstring/ bit and back up to the surface



Mud pumps
- Duplex
- Triplex



Main Rig Components-2

- Circulating system: Delivers the hydraulic power (HHP) req'd to pump/ move the drilling fluid from surface tanks (pits), through the drillstring/ bit and back up to the surface

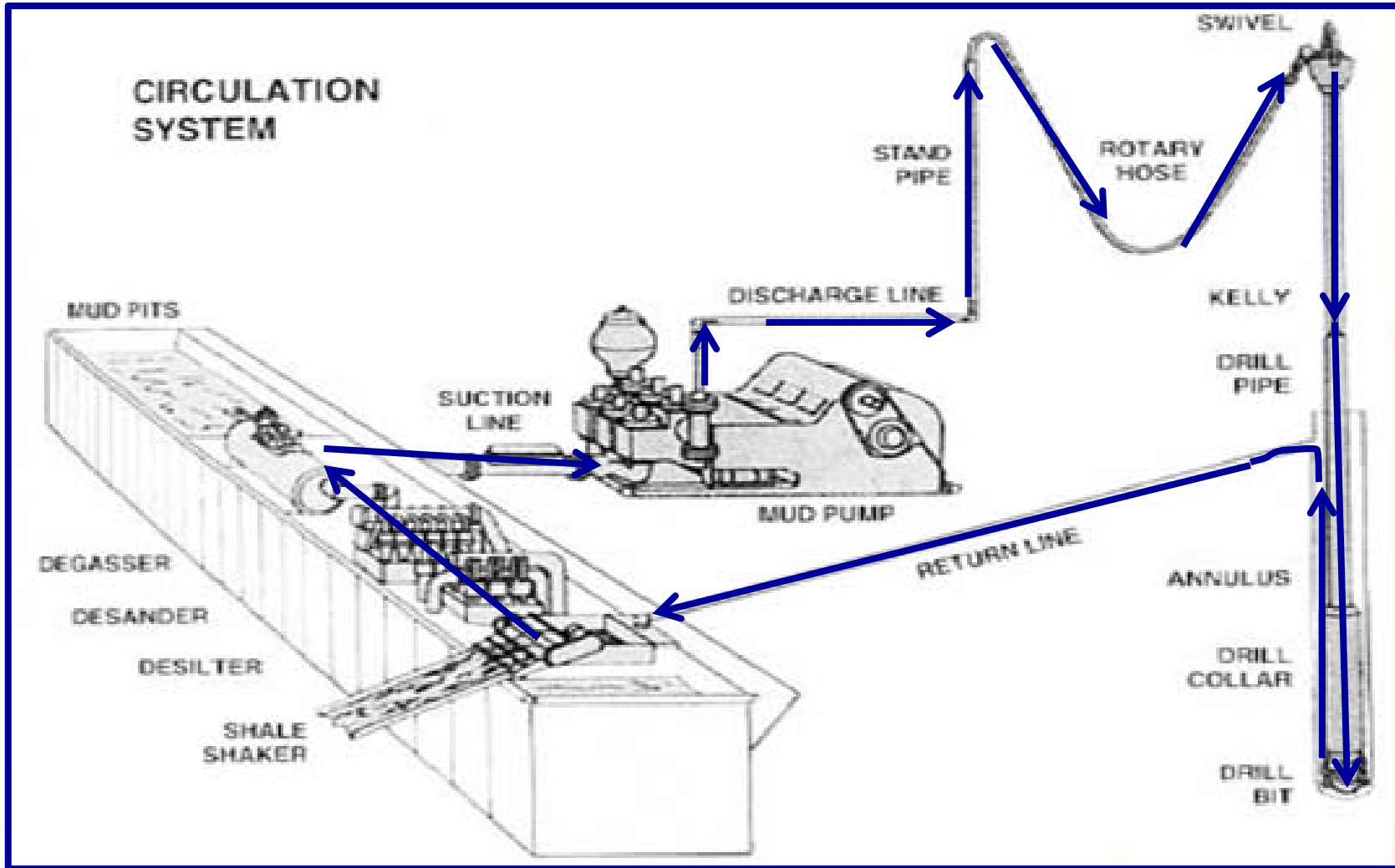

Main Rig Components-3

- Hoisting/ Lifting system: To raise & lower the drillstring into the well. Starts at the deadline anchor point and ends at the drawworks

Drawworks



Main Rig Components-3

- Hoisting/ Lifting system: To raise & lower the drillstring into the well. Starts at the deadline anchor point and ends at the drawworks

Lifting System components

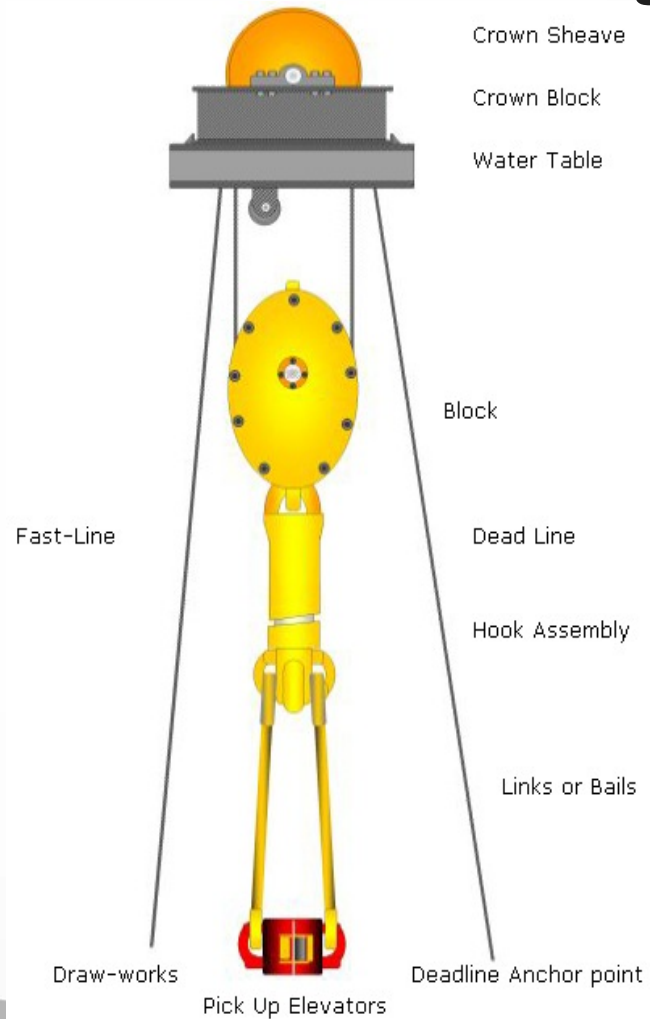

Classification of rotary rigs

Rigs can sub-divided accordingly to the conditions, location and environments that exist

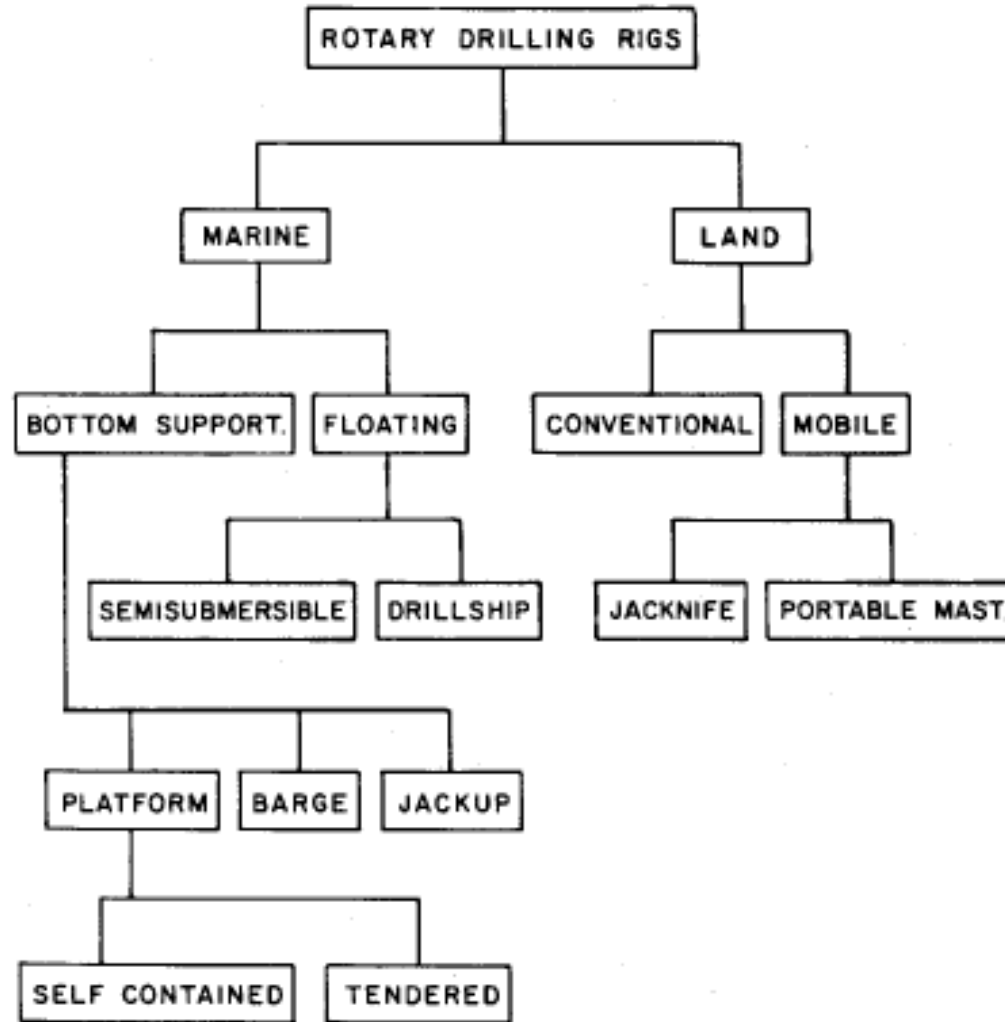

Land Rigs

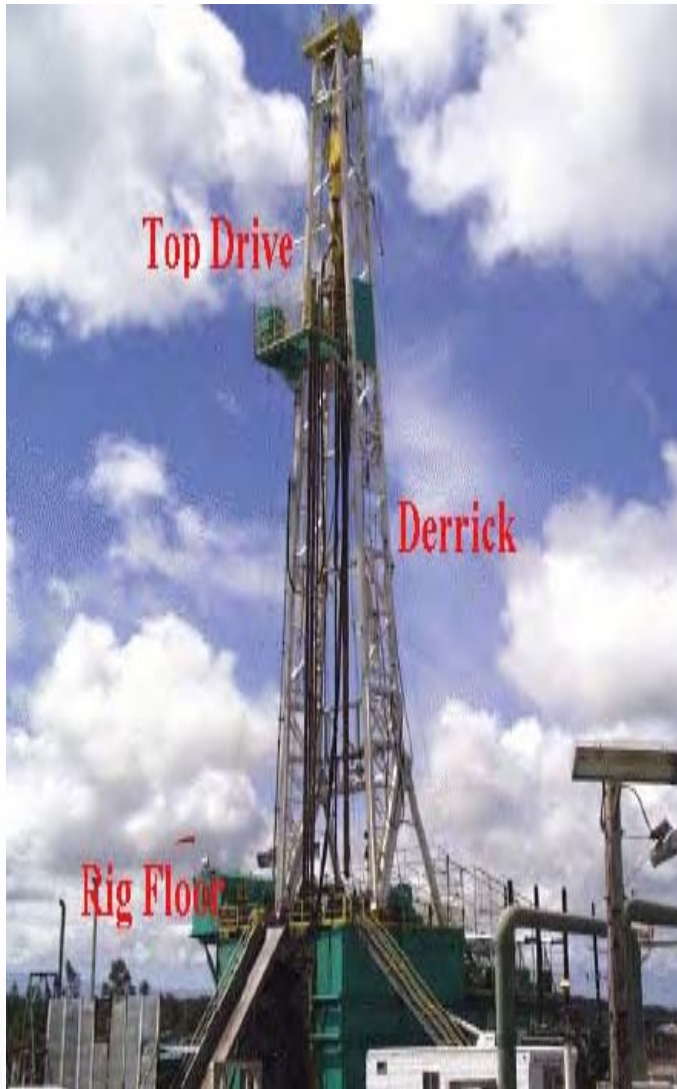

Offshore Rigs

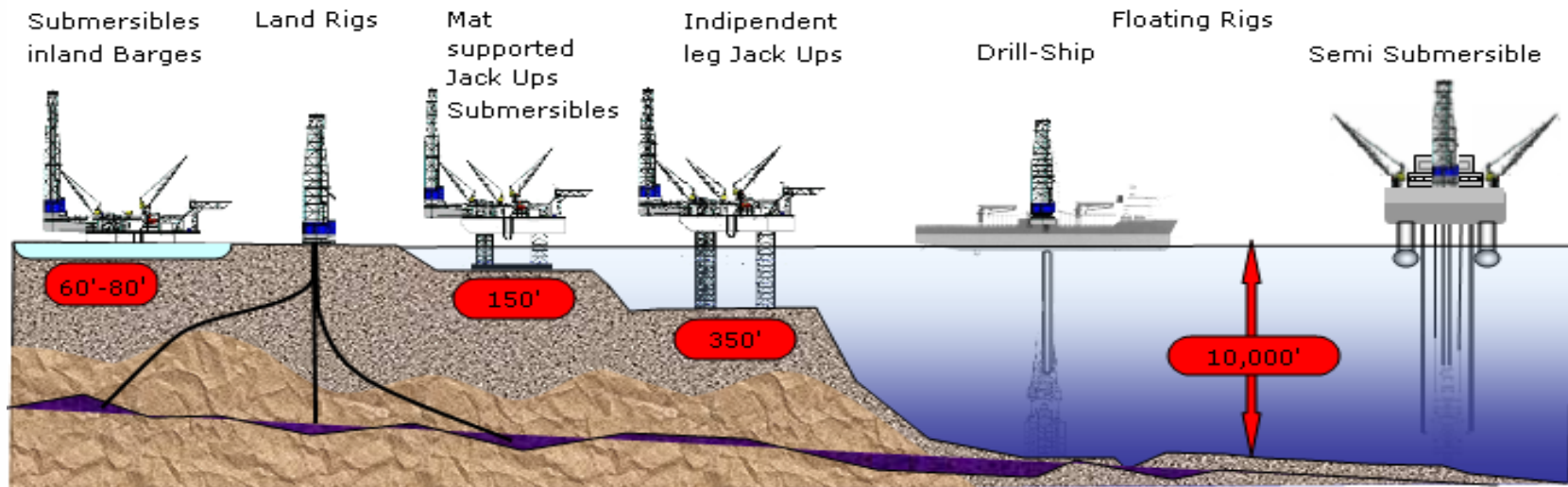

- **wildcat wells:** drilled outside of & not in the vicinity of known oil or gas fields
- **exploration wells:** drilled purely for exploratory (information gathering) purposes in a new area
- **appraisal wells:** used to assess characteristics (such as flow rate) of a proven hydrocarbon accumulation
- **development wells:** drilled within the boundaries of a known producing reservoir to increase the production in the field
- **offset well:** a type of development well that is drilled near a well that is producing or had previously been productive
- **production wells:** drilled primarily for producing O & G, once the producing structure & characteristics are determined
- **disposal well:** used to dispose of produced water, drilling cuttings or any other unwanted fluid
- **water or gas injectors:** drilled to inject (water or gas) into the reservoir to maintain reservoir pressure
- **storage well:** drilled to store hydrocarbons for later production (strategic reserves)

Ideally, all wells would be drilled vertically, with the rig positioned on the surface and directly above the sub-surface target. But that is not always possible. For example, if drilling close to a city or populated area, the target may be located under construction, building or houses. In this case, the rig and surface location of the well will be at some distance away from it.

In the case of a drilling offshore platform (fixed structure), several wells, each with a different geological target can be drilled from the same location

A well design and profile can become quite complex and difficult. Today technologies has made possible drilling wells than in the past were considered un-drillable

Well profiles/ designs

The type of profile selected will depend upon the geological objectives and the production mechanism of the well

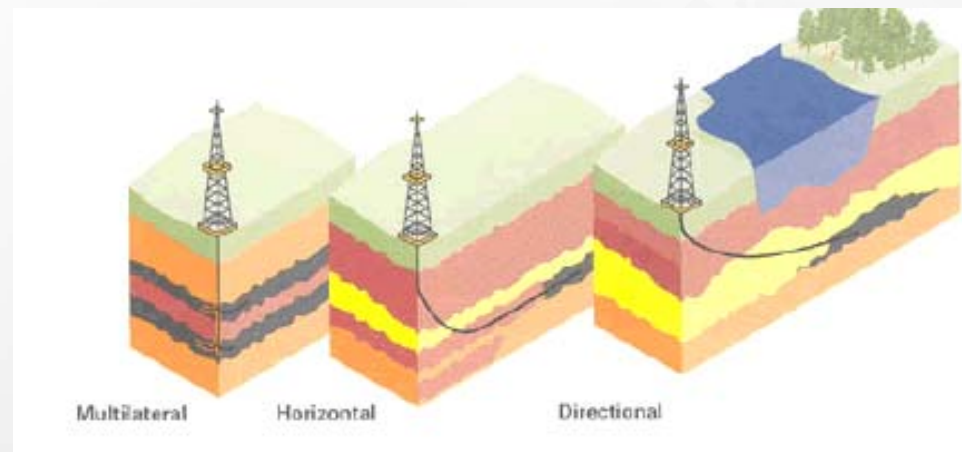
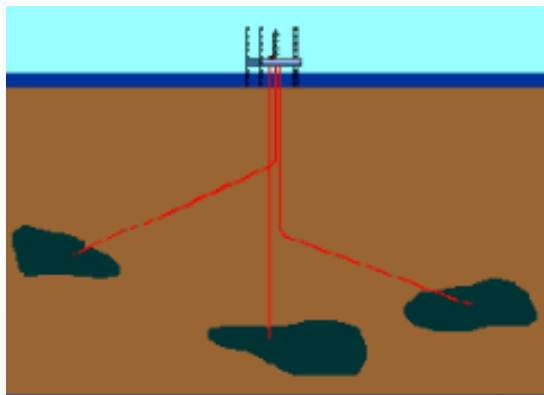
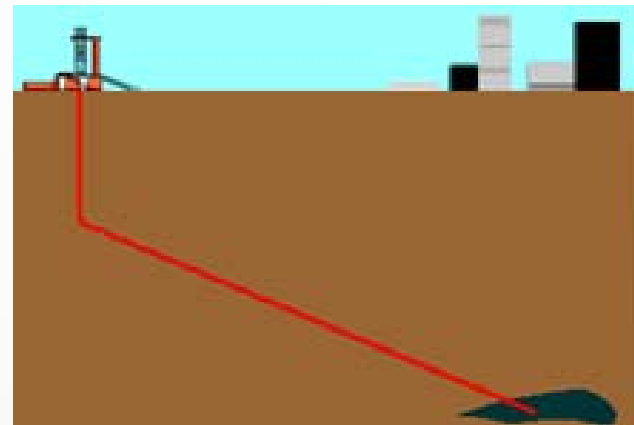
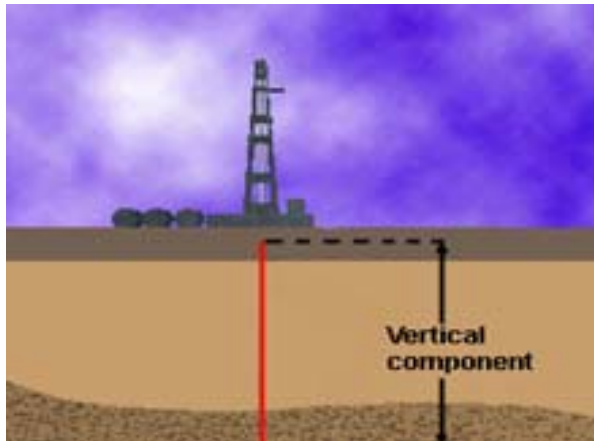

Well profiles/ designs

Today, wells with highly complex profiles and designs are planned and drilled. Advances in drilling tools, MWD/ LWD, metallurgy, survey accuracy and drilling dynamics make these wells possible

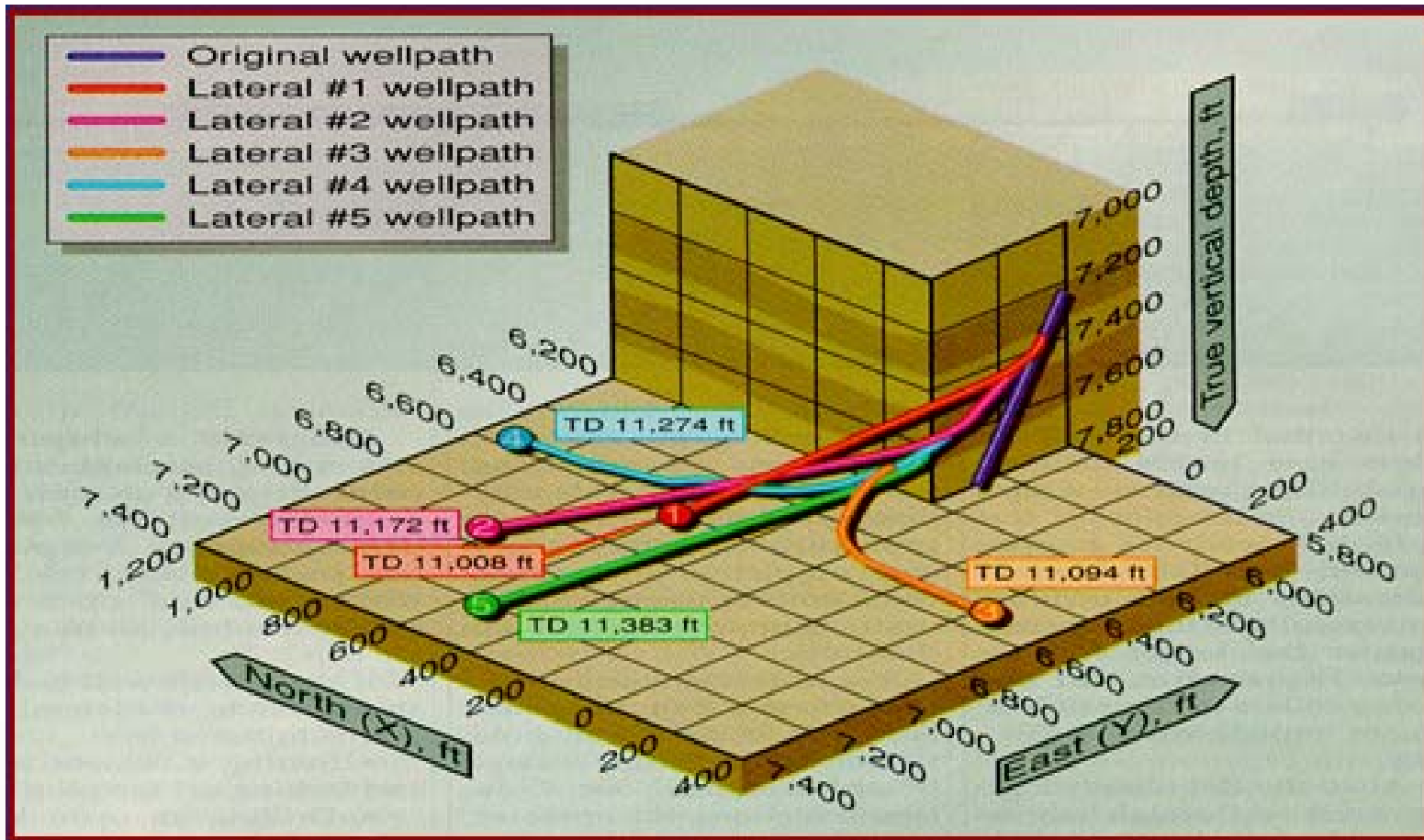

- Vertical / straight: have a bore with no planned deviation from vertical
- Directional: where the it is not desirable or possible to locate the surface location directly above the target or a multiwell platform
 - Build- Hold- Drop (S type): S-type wells have a bore with a straight section, a build section, a tangent section and a drop section. S-type wells can ensure accuracy in bottom hole spacing when multiple wells are drilled from the same platform. Target location is not too far from surface
 - Build- Hold (J type or slant): have a bore with a straight section, a build section, and a tangent section straight to the target. Target location can be far from the surface

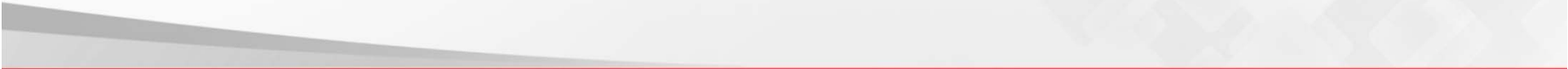

Typical well profiles

Vertical/ Straight hole

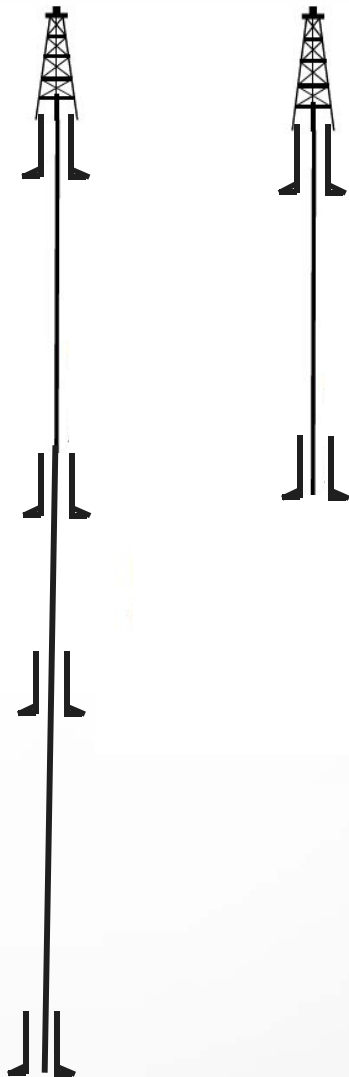

Directional Build & Hold

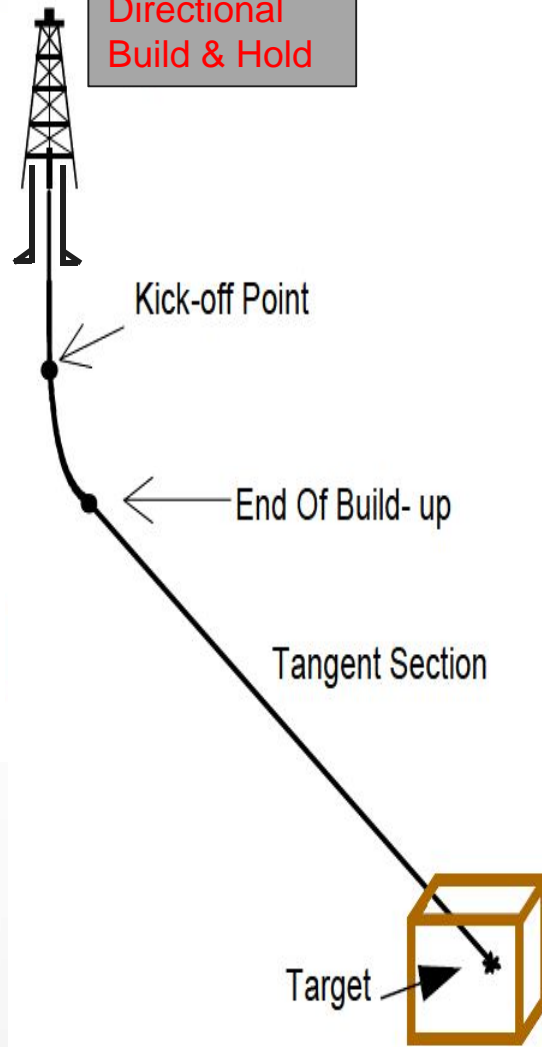

Directional Build, Hold & Drop

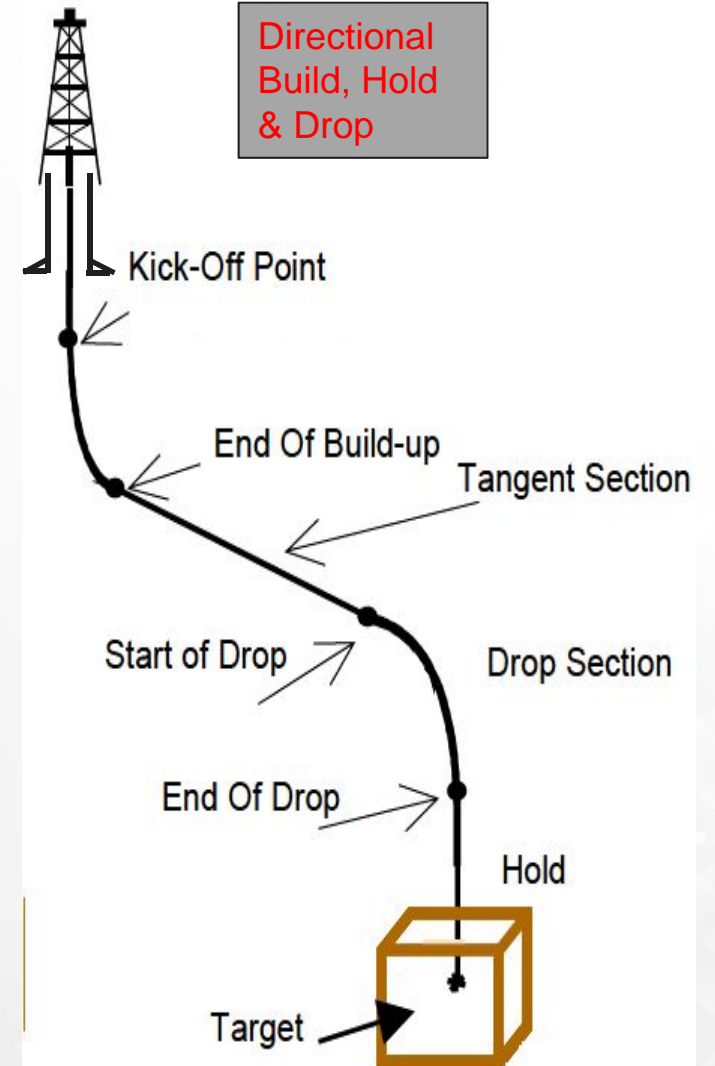

- Directional wells can have either a shallow kick off point, like the ones shown in previous slide, or deep kick one like the first on this slide

- Horizontal: have a bore with a straight section, a build section, tangent section, a second build section (most of the time), and a horizontal section
 - Short
 - Medium
 - Long radius horizontal wells

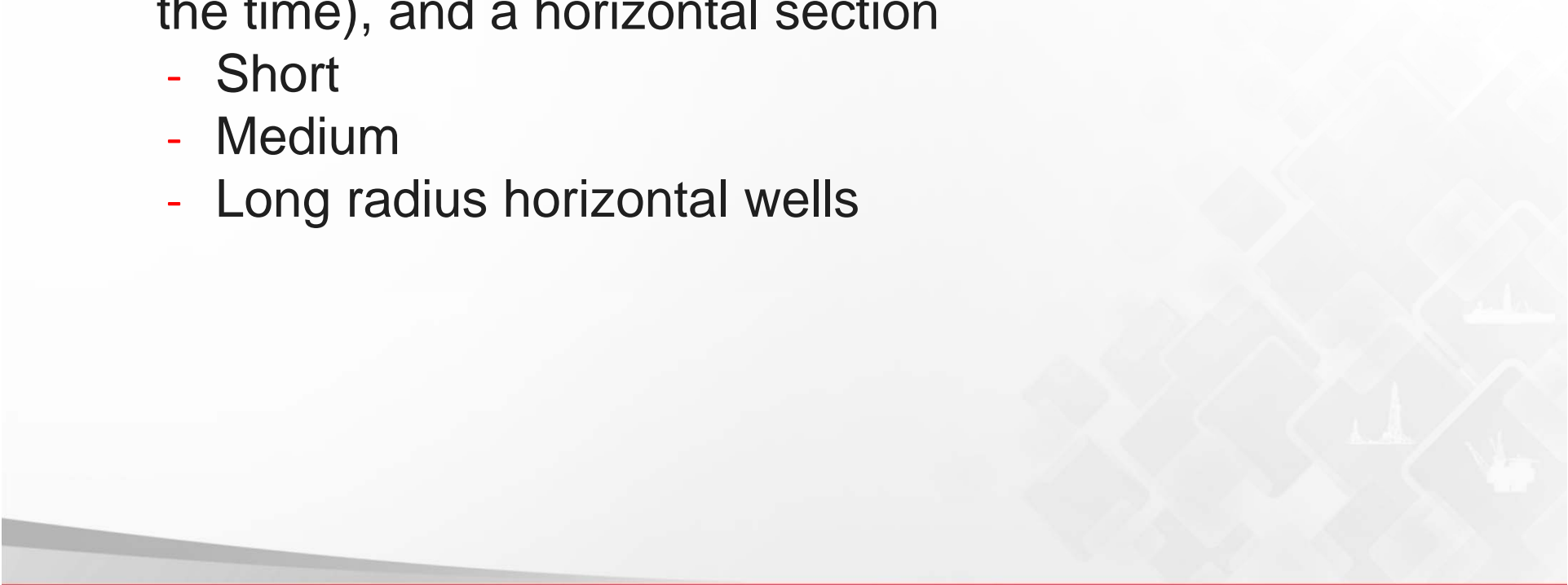

Typical well Profiles (cont...)

Directional w/ deep kick off

Horizontal or Lateral

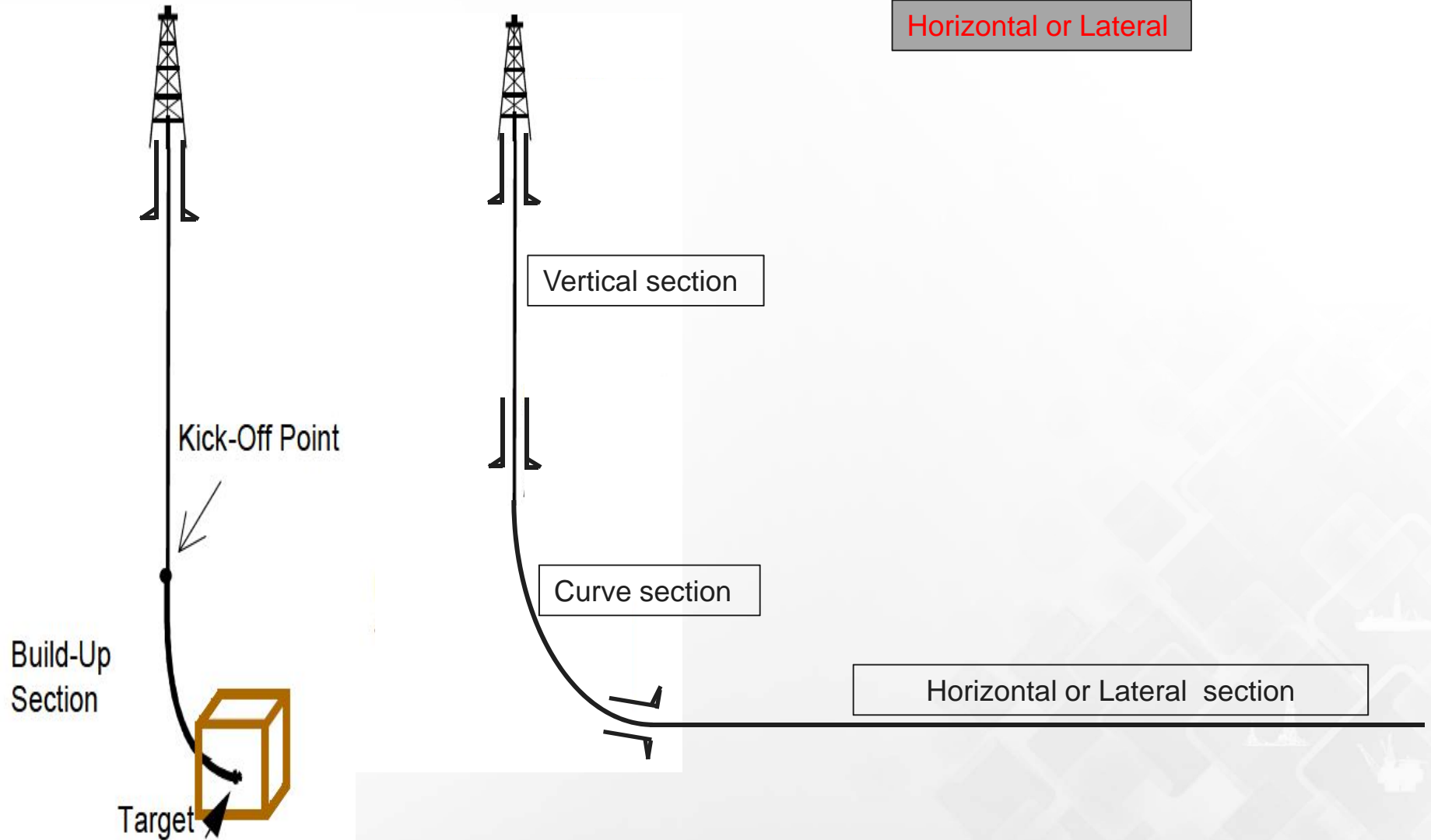

- Multilateral: Multilateral wells have several wellbores running laterally and originating from one original hole
- Multilateral types
 - Stacked
 - fishbone



Typical well Profiles (cont...)

Multilateral

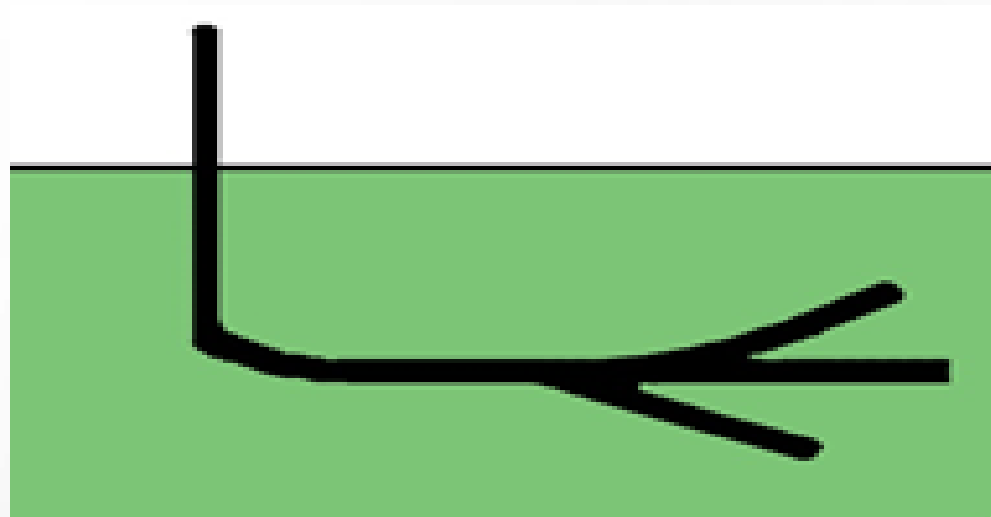
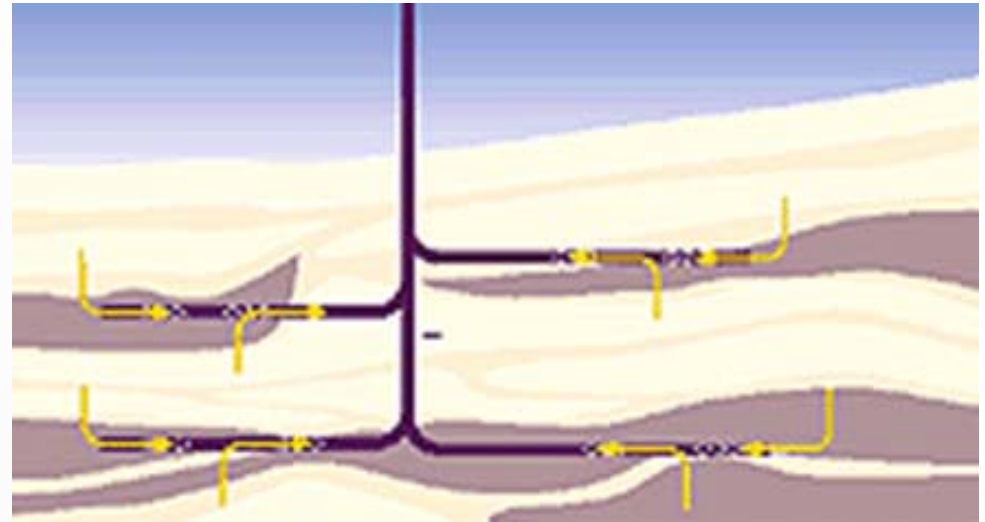
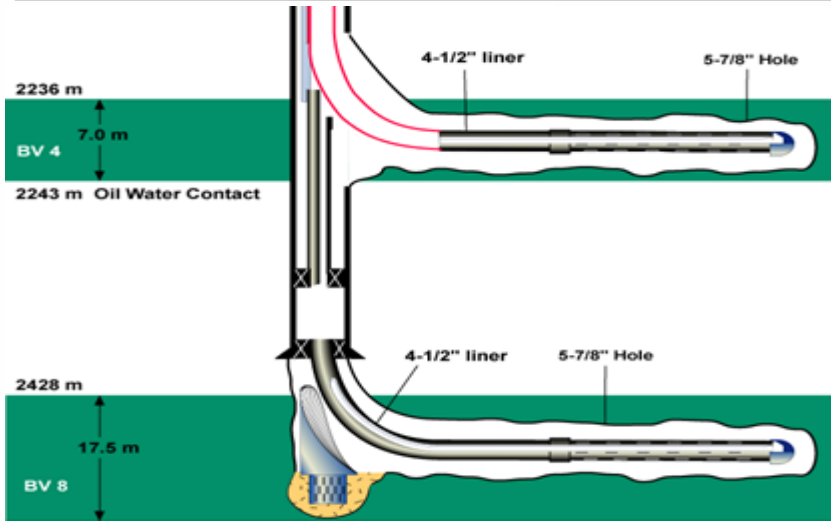

- Extended Reach (ERD): Extended reach are directional wells drilled to reach reservoirs that have a horizontal displacement in excess of 16,400 ft (> 5,000 m) from the starting point. The aims of ERD are: a) to reach a larger area from one surface drilling location, and b) to keep a well in a reservoir for a longer distance in order to maximize its productivity and drainage capability
 - On 28 January 2011 the world's longest borehole (8 ½") was drilled at the Odoptu field, Sakhalin-I with a measured total depth of 12,345 m (7.7 miles, 40,502 ft) and a horizontal displacement of 11,475 m (7.2 miles, 37,648 ft). It was drilled in just 60 days

Typical well Profiles (cont...)

ERD= Extended Reach

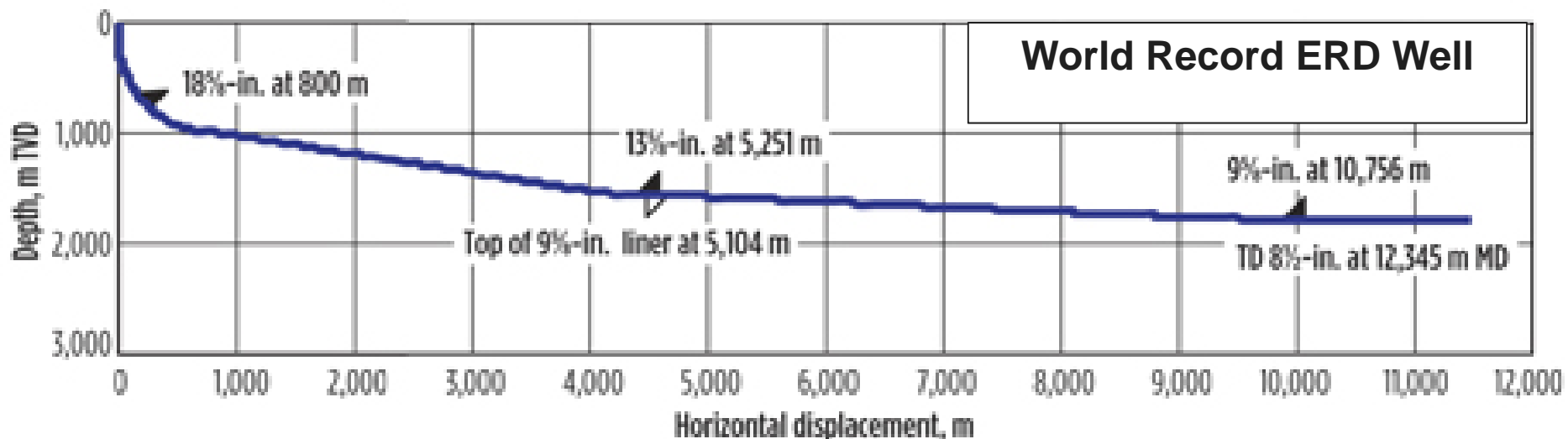
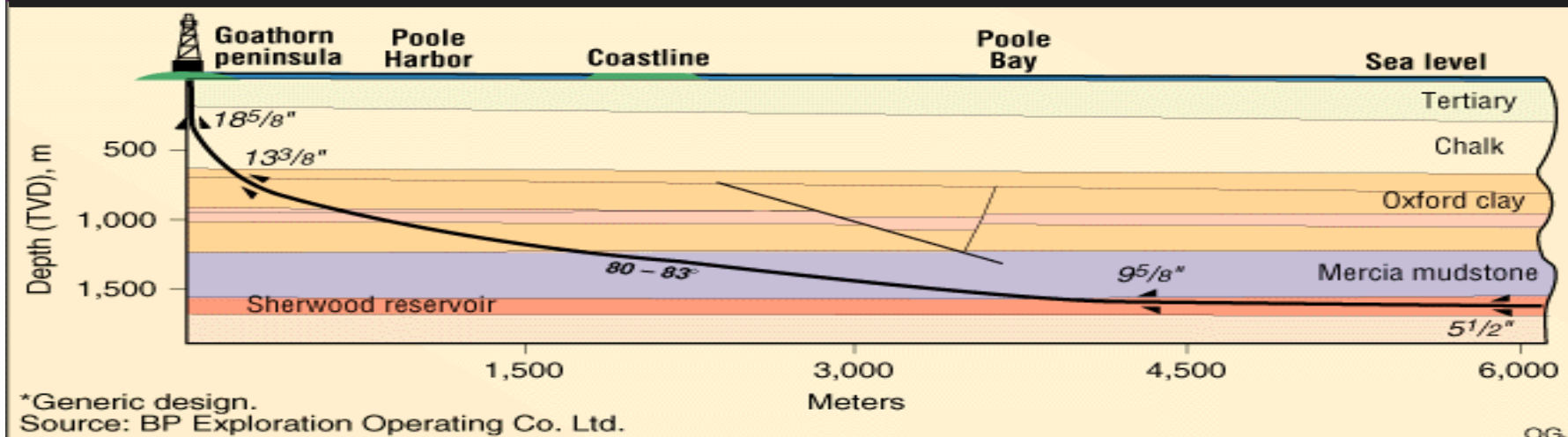

What is a drillstring?

- A drillstring is the combination of all tubular (pipes) run in the hole for drilling purposes. The most common components are:
 - Drill pipe
 - Heavy Weight drill pipe or HWDP or Hevi-Wates
 - Drill Collars
 - Stabilizers
 - Subs
 - Float valve
 - Jars

- A BHA (Bottom Hole Assembly) is the lowermost part of the drillstring and consists of:
 - Drill Bit
 - Mud Motor
 - MWD (measuring while drilling) or LWD (logging while drilling)
 - Stabilizers and subs

Drillstring Components- 1

Drill pipe is used to extend the depth of the well. Although there are many grades, weights and sizes, there are only 3 lengths ranges.

A joint of pipe can be broken down into 3 sections.

| Grade | Yield Strength | | Maximum Tensile Strength psi |
|-------|----------------|---------|------------------------------|
| | Min psi | Max psi | |
| D | 55000 | ----- | 95000 |
| E | 75000 | 10500 | 100000 |
| X95 | 95000 | 125000 | 105000 |
| G-105 | 105000 | 135000 | 115000 |
| S-135 | 135000 | 165000 | 145000 |

The Box. Connection

The Tube "Body"

The Pin Connection

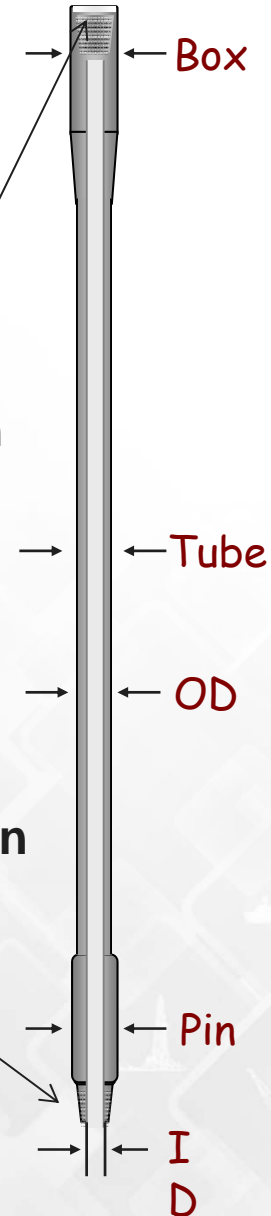

Drillstring Components- 1

Drill Pipe Sizes
3-1/2", 4", 4-1/2", 5", 5-1/2" and 6-5/8"



Drillstring Components- 2

Heavy Weight Drill pipe (Heviwates or HWDP)



Hevi-Wate Drill Pipe (HWDP) is a thick-walled pipe that looks just like the DP but weighs a lot more. The internal diameter is smaller. It is used for many reasons:

- Keeps the transition zone out of the drill pipe
- Used in high-angled or horizontal wells instead of drill collars
- Keep tension on the drill pipe while drilling.

HWDP can be recognised by the oversized centre and the amount of hard banding that is on the tool joints

HWDP can be ordered in two ranges: Range 2 and Range 3

Sizes are the same as those of drill pipes (3-1/2" to 6-5/8")



Drill Collars (DC's)

- Heavy, stiff steel tubulars (much heavier than DP & HWDP)
- Used at the bottom of a BHA to provide weight on bit and rigidity
- The primary function is to provide sufficient WOB (Weight on bit)
- The DC's also ensures that the DP is kept in tension to prevent buckling.
- DC can be slick (flush) or spiral

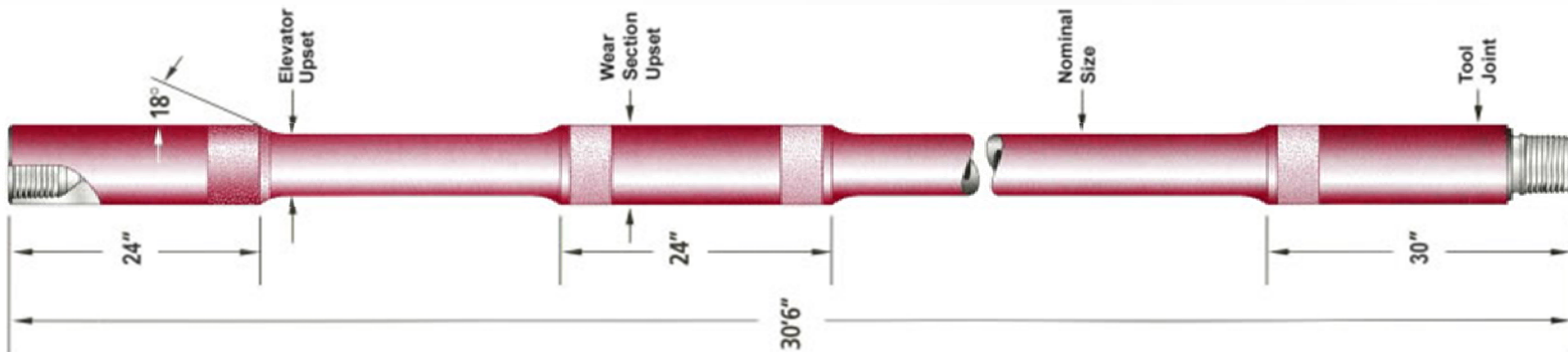

DC sizes can be from 3 1/8" to 11"

Stabilizers

- Center/ stabilize the drillstring components in the drilled hole
- Reduce the are of contact of the components with the borehole
- Stabilizers are used with any type of drilling assembly
- Stabs are used to control hole deviation
- If correctly used, stabs may improve hole quality, rate of penetration and prevent many undesirable drilling issues, including stuck pipe, hole spiraling and harmful vibration



Types of Stabilizers

- Welded
- Integral
- String and nearbit
- Straight Blades/ Spiral blades
- Replaceable sleeves / non-rotating sleeve
- Variable gauge/diameters

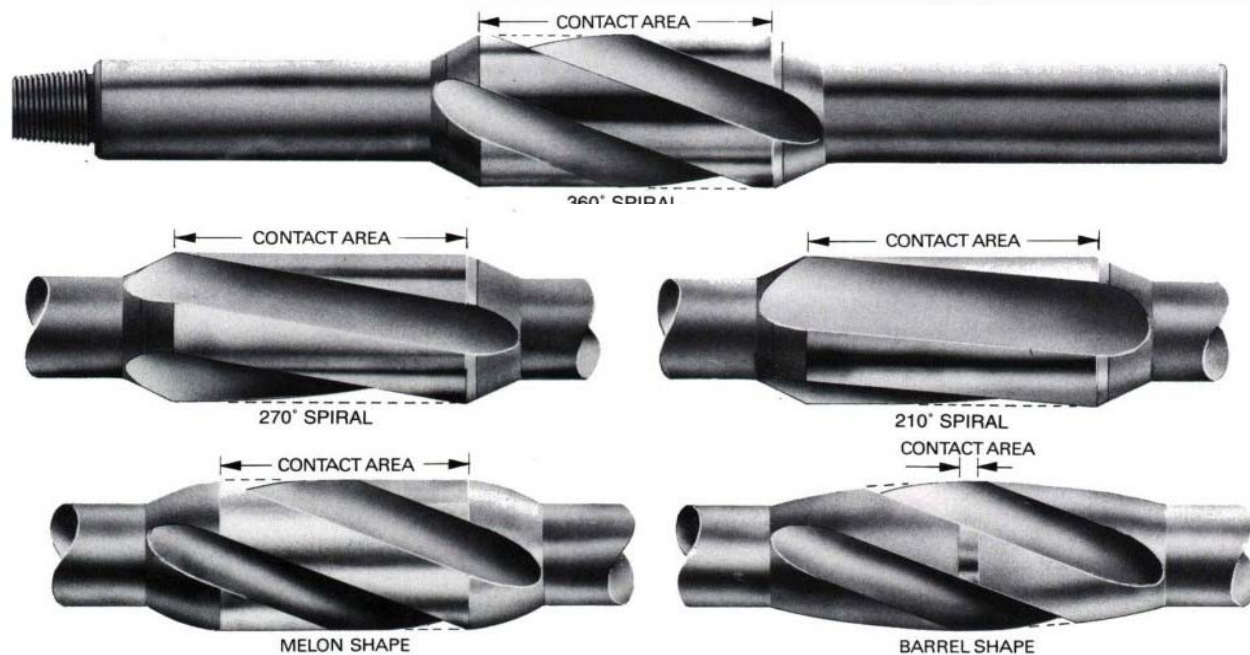

• Drillstring Components- 5

Jar & Accelerator

- Used to free stuck drill strings or to recover stuck components

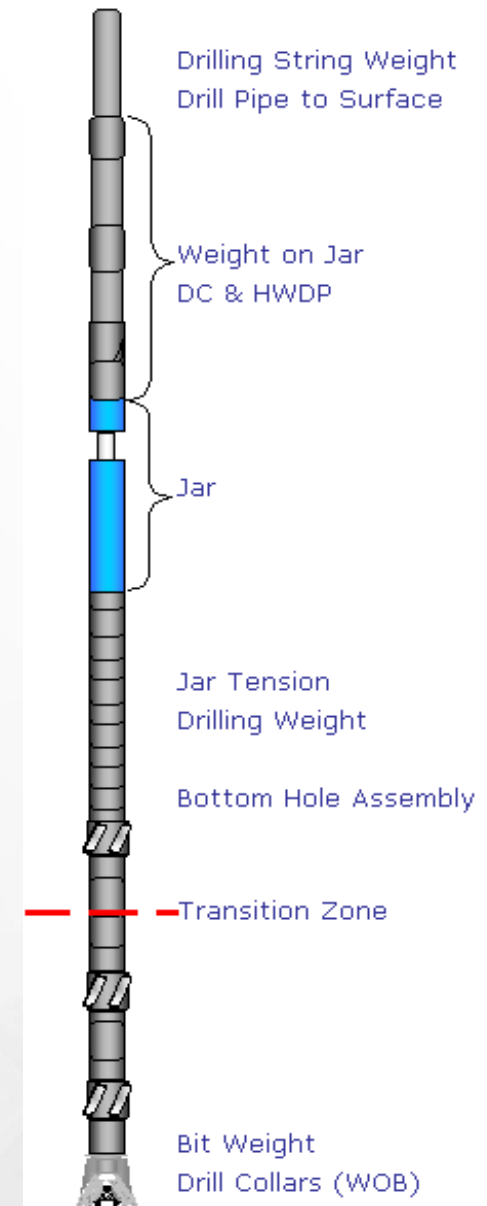
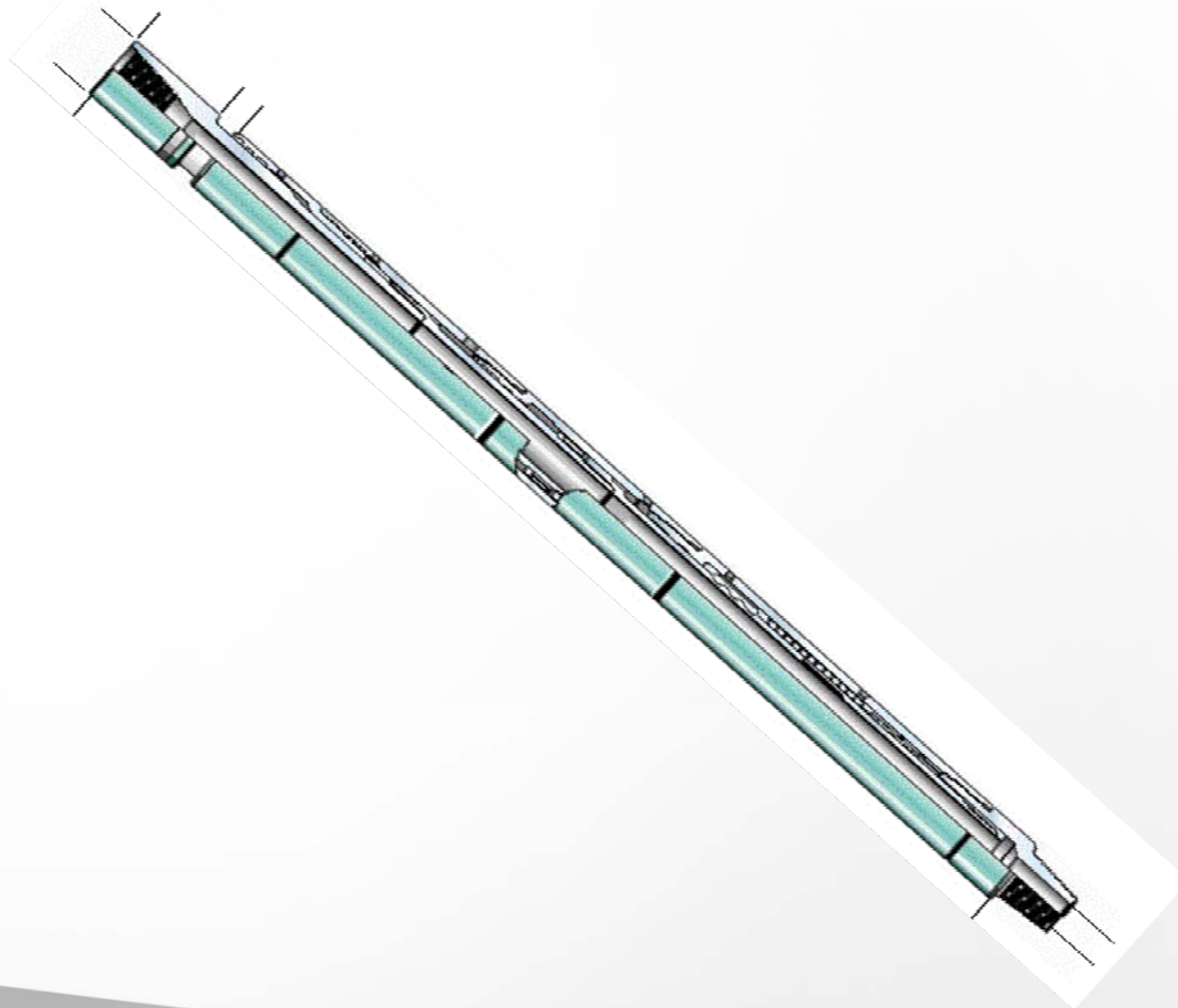

• Drillstring Components- 5

Shocks Absorber

- Absorbs or dampen axial vibrations
- Prevent failures of other components

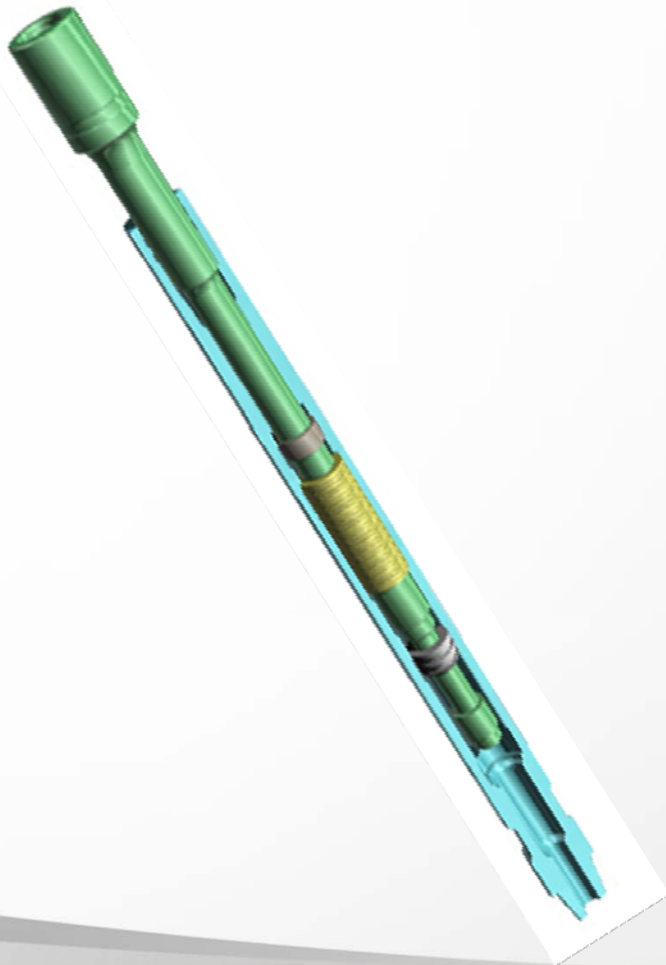

Subs & Crossovers (XO's)

- Make up components with different OD & connections/ threads
- Special applications



Straight OD Subs

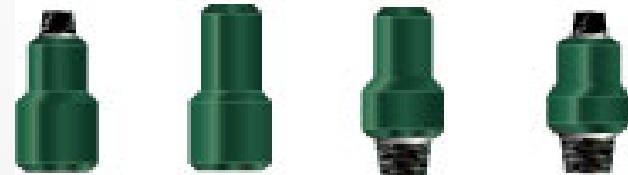

Reduced Section Subs

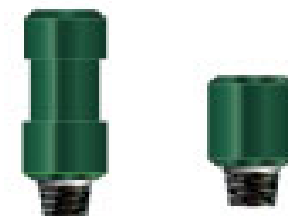

Saver Subs

Drilling Tools- Mud Motors

- Mud Motors are run right above the drill bit
- Are used to improve drilling performance in any type of wells
- Provide rotation to the drill bit without rotating the drillstring
- In directional drilling, a motor is used to deviate from vertical, build angle & steer the well to its geological/ subsurface target
- Motors provide additional energy to the bit
 - Convert hydraulic to mechanical energy
- Increases the rate of penetration

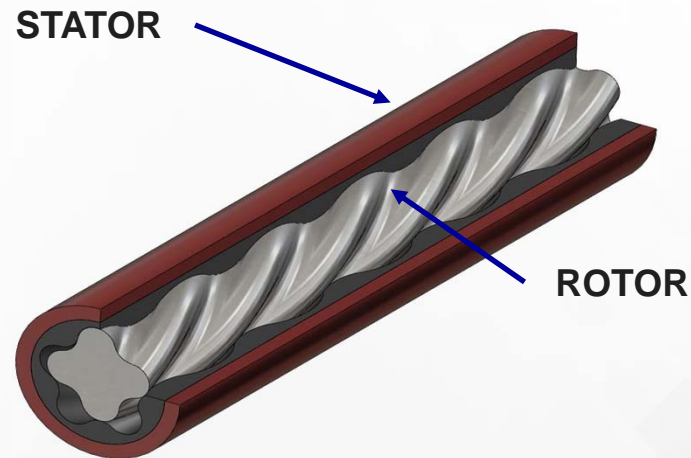

Main parts of a mud motor

- Power Section
- Transmission Section
- Bearing Section

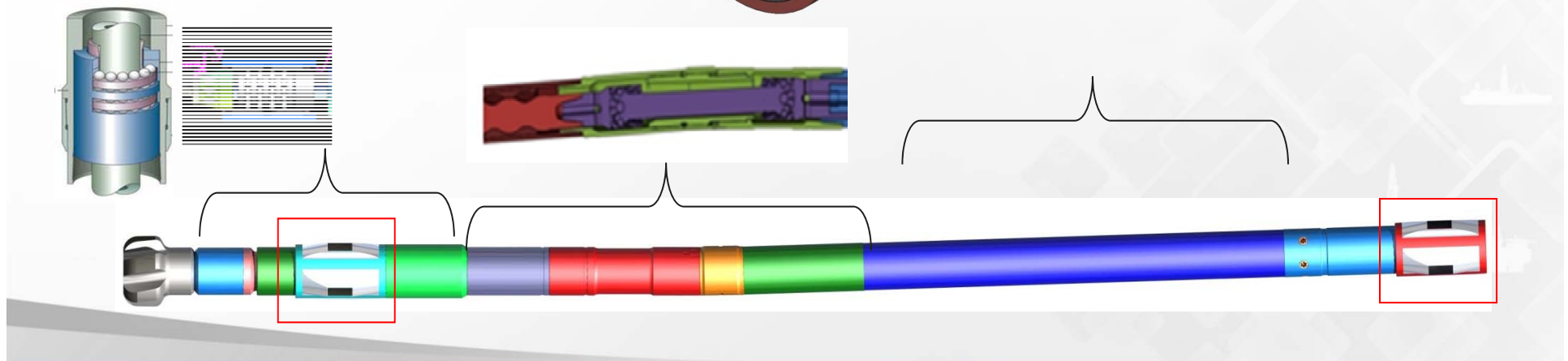

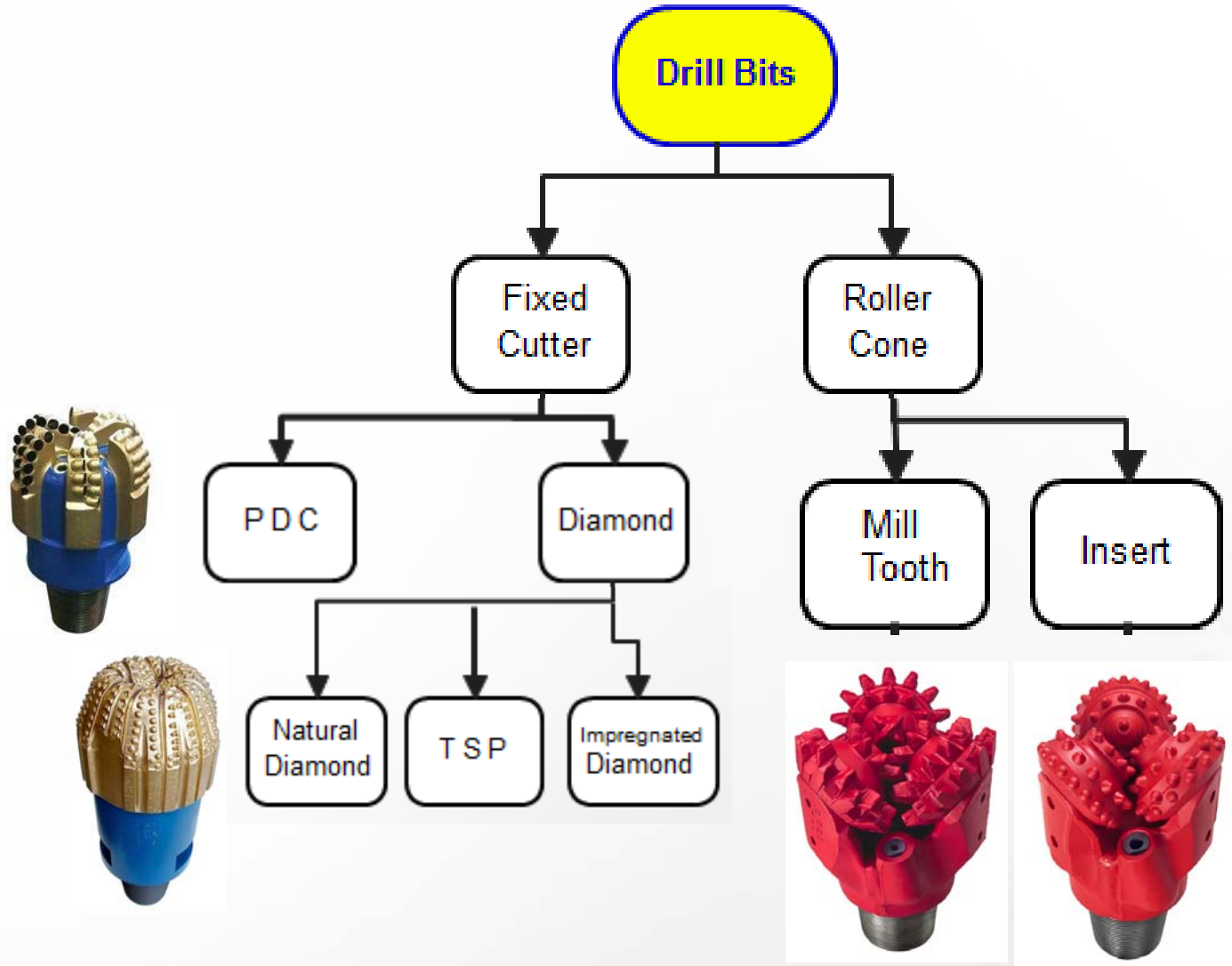

PDC Cutter sizes



- **PDC= Polycrystalline Diamond Compacts**
- **PDC cutters are manufactured with man made diamond material**

Drilling Tools- Bits

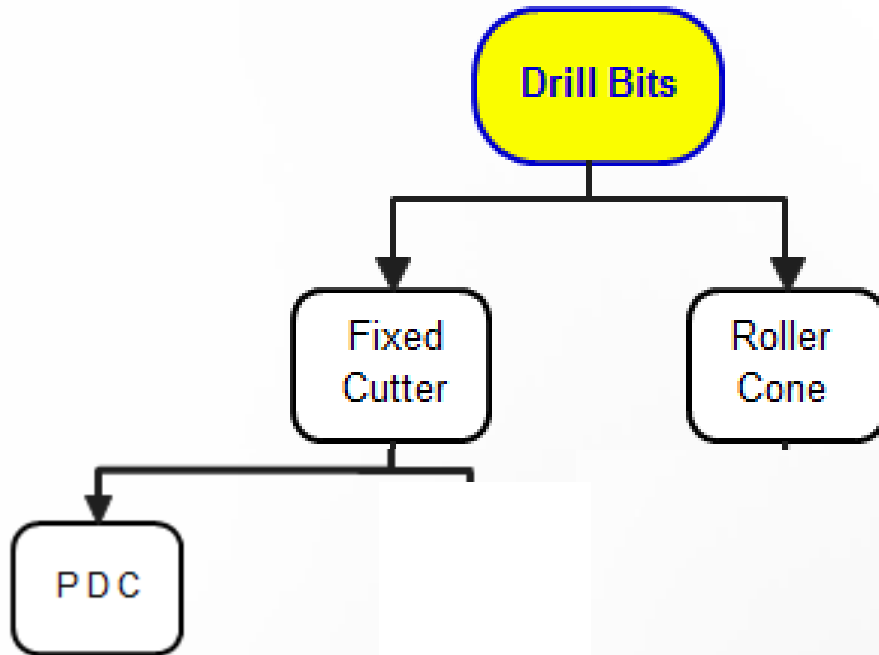

Advantages

- Very Fast ROP
- Long Life Potential

Disadvantages

- Impact Damage
 - Abrasiveness
 - Stability
-
- ROP vs. Durability

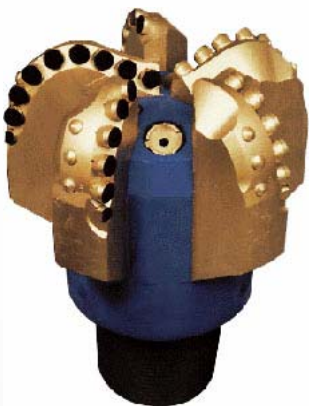

what these bits good for?

- **PDC bits are also know as “Drag Bits” because they shear / drag the rock as they cut it and were originally designed to drill these types of formations:**
 - **Soft to medium hardness (strength)**
 - **That can be drilled at high ROPs, very fast**
 - **Low abrasivity**
 - **Lithology type predominantly shale, claystone**
 - **Drilling parameters**
 - **Rotary/ top drive: low-medium WOB & medium high RPM’s**
 - **Mud Motor: high power (high torque) & medium speed (RPMs)**
- **As technology advanced, new materials and processes were developed, today PDC bits can be used to drill much harder and abrasive rocks than before and can drill with much flexible range of parameters (WOB, RPMs, torque)**

PDC bits after use



Natural Diamond Bits

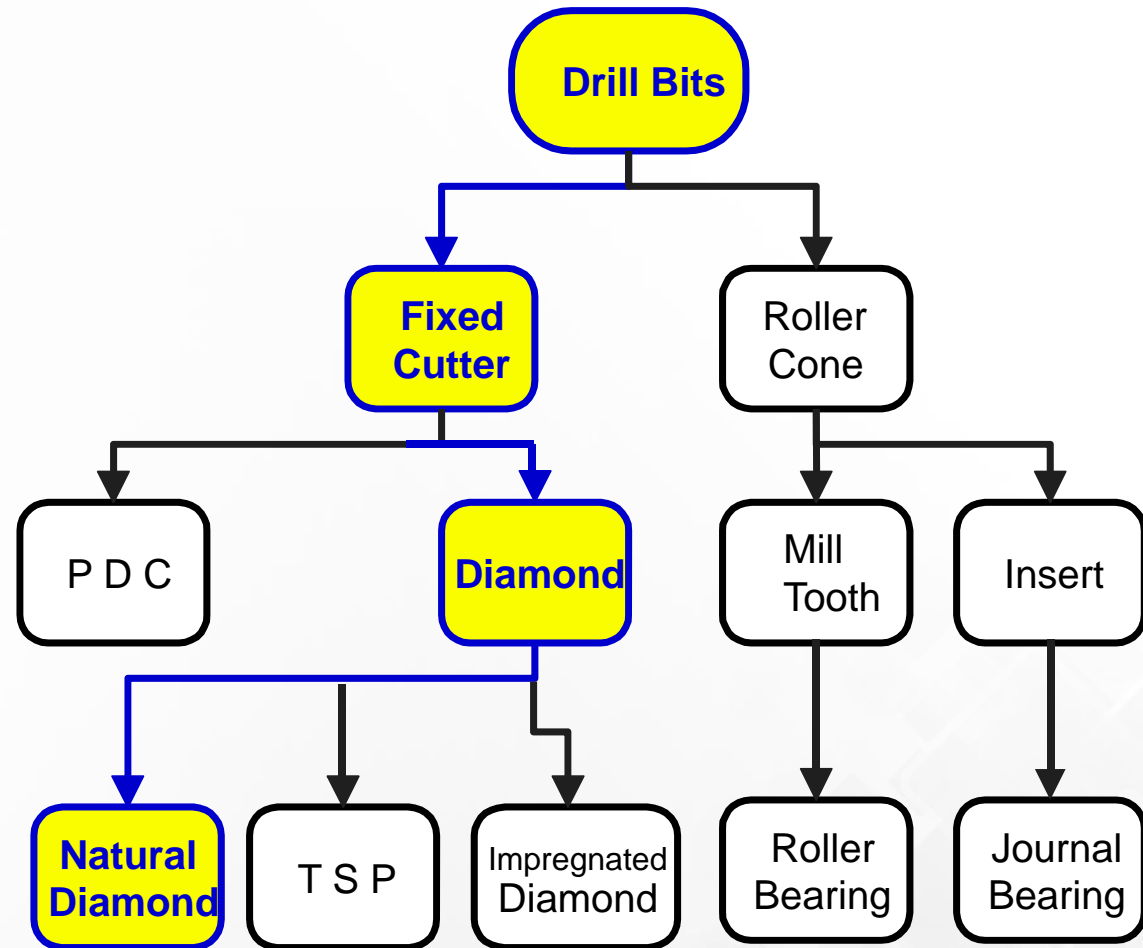
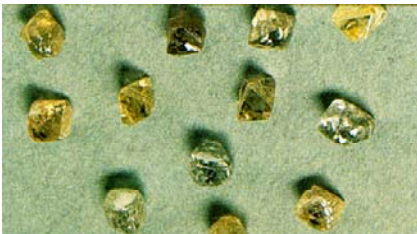

Natural diamond bits are almost always run with high speed mud motors or drilling turbines

What are these bits good for?

- Hard and abrasive formations where a PDC or tricone will not last very long. These rocks are drilled by a grinding effect of the diamond stones on the formation
- ROP are typically low, typically not higher than 10 feet/ hr and as low as less than 1 feet/hr
- Can drill for long drilling time, much longer than a PDC
- Natural diamond bits can be run with rotary or with a mud motor or turbine. The speed (RPM) depends on the size of the diamond stones. The smaller the stones, the higher the RPMs generally is
- Today, ND bits are not very common as most have been replaced by either new PDC designs or impregnated bits

TSP's resist / stand much higher temperature than a PDC cutter

TSP=Thermally Stable Polycrystalline Diamond

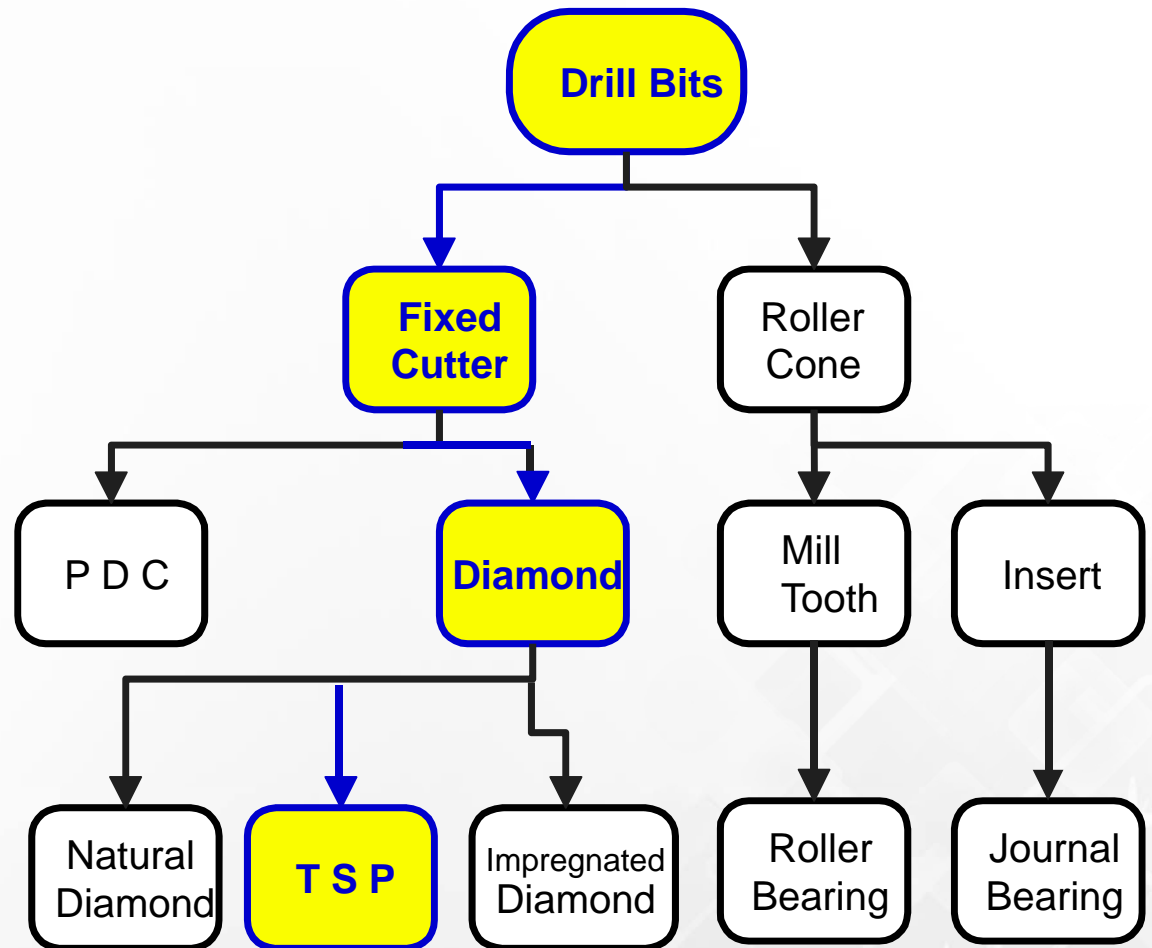

TSP is a man made diamond which is thermally stable at very high temperature, at which a PDC cutter will generally fail. These high temperatures are reached when drilling hard/ abrasive rocks at very high RPM's. That's why a PDC bit cannot be used to drill these types of rocks

TSP bits are good to drill:

- Hard and abrasive formations at high RPMs where PDC are not suitable due to the high heat (temperature) generated by friction with the formations
- Typical rocks, best application: homogeneous sandstone with low % or none shale or clay
- ROP's can be low (less than 5 ft/hr) to medium-low (less than 20 ft/hr) depending on formation strength (hardness) & size of the TSP stones
- Can drill for long drilling time, like a ND bit
- Like a ND bit, TSP bits can be run with rotary or with a mud motor or turbine. The speed (RPM) depends on the size of the diamond stones. The smaller the stones, the higher the RPMs generally is
- Today, TSP bits are not very common as most have been replaced by either new PDC designs or impregnated bits

Impregnated Bits



Advantages

- Very Durable
- Hard Rock Capability
- Low Junk-in-Hole Risk

Disadvantages

- Slower ROP
- RPM Sensitivity
- High Cost Applications
- ROP vs. Durability

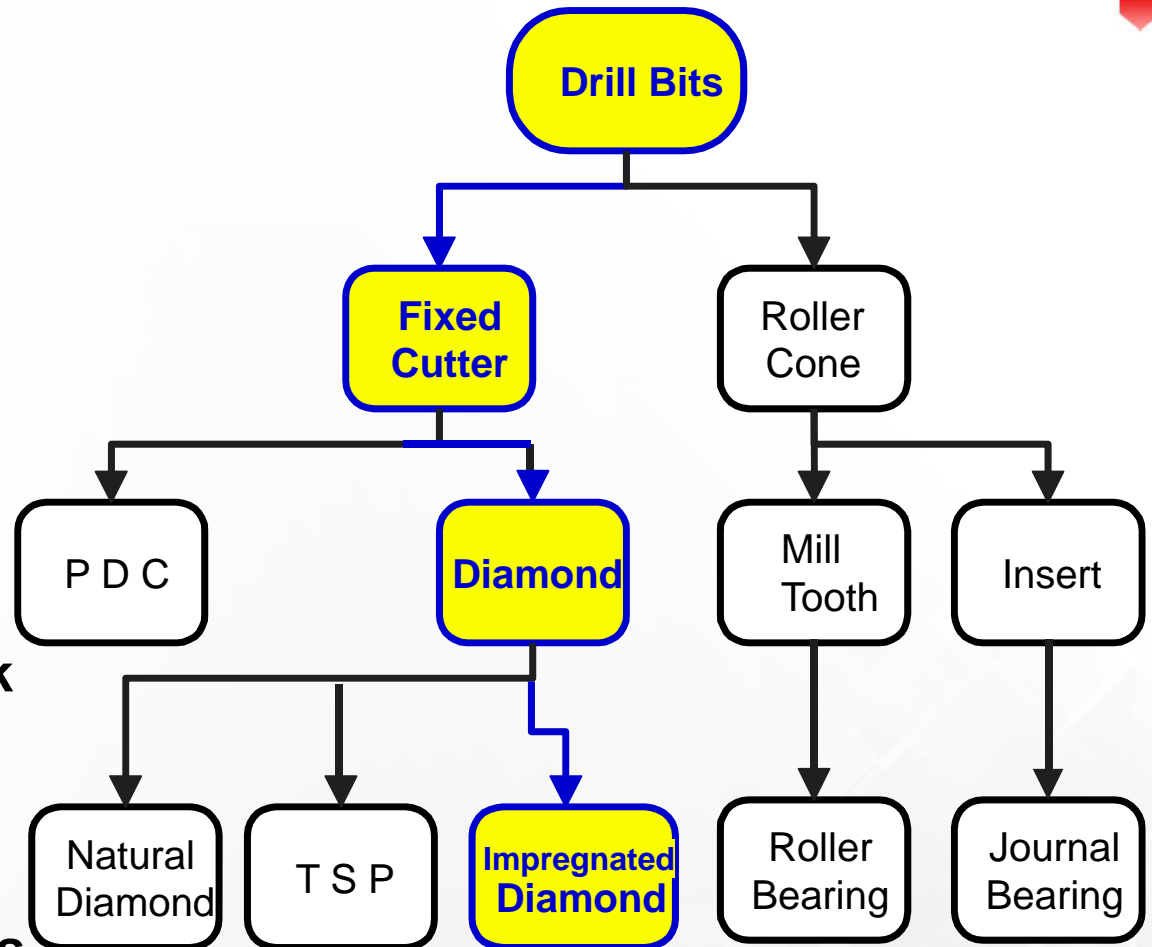

Impregnated bits are made with very fine grain/ powder Thermally Stable Polycrystalline Diamond

Impregnated are another type of TSP bits and are made with very fine powder TSP diamond product.

Impregnated bits are good to drill:

- The hardest and most abrasive formations and rocks where other bits will not last
- Are always run with turbines or high speed motors
- ROP's are usually low to very low (5 to less than 1 ft/hr)
- A impregnated bit can last several hundreds hours

Other names for Roller Cone bits: Rock Bit, Tri-Cone™

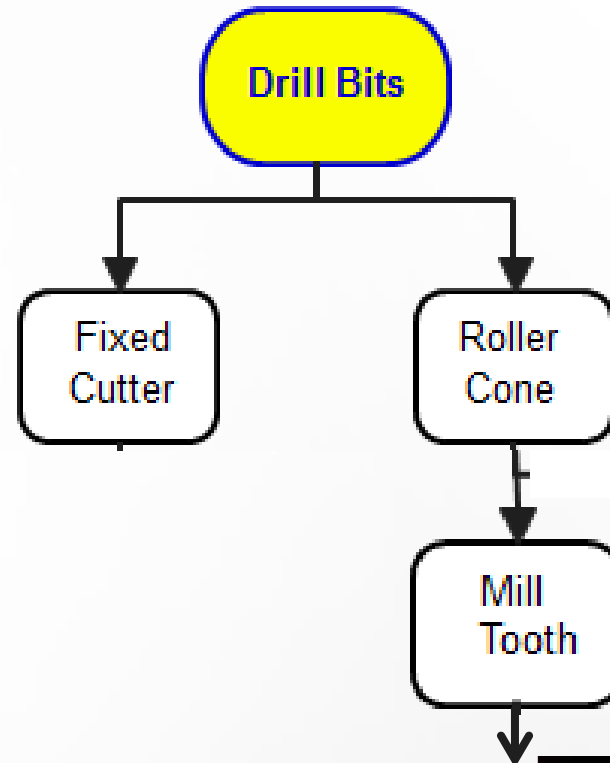

Mill Tooth Bit Advantages

- Fast ROP
- Good Stability
- Economic

Disadvantages

- Tooth Wear Rate
- Bearing Life

ROP vs. Durability

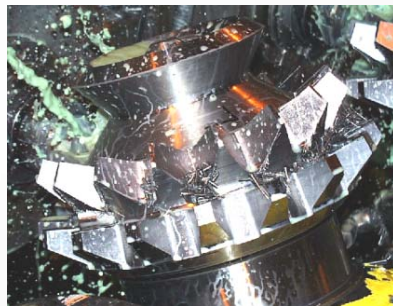

Insert Bit Advantages

- Cutting Structure Durability
- Range of Formations
- Interbed Tolerance
- Steerability and Stability

Disadvantages

- Slower ROP
- Bearing Life
- Risk of Junk-in-Hole

ROP vs. Durability

Other names for Roller Cone bits:
Rock Bit, Tri-Cone™

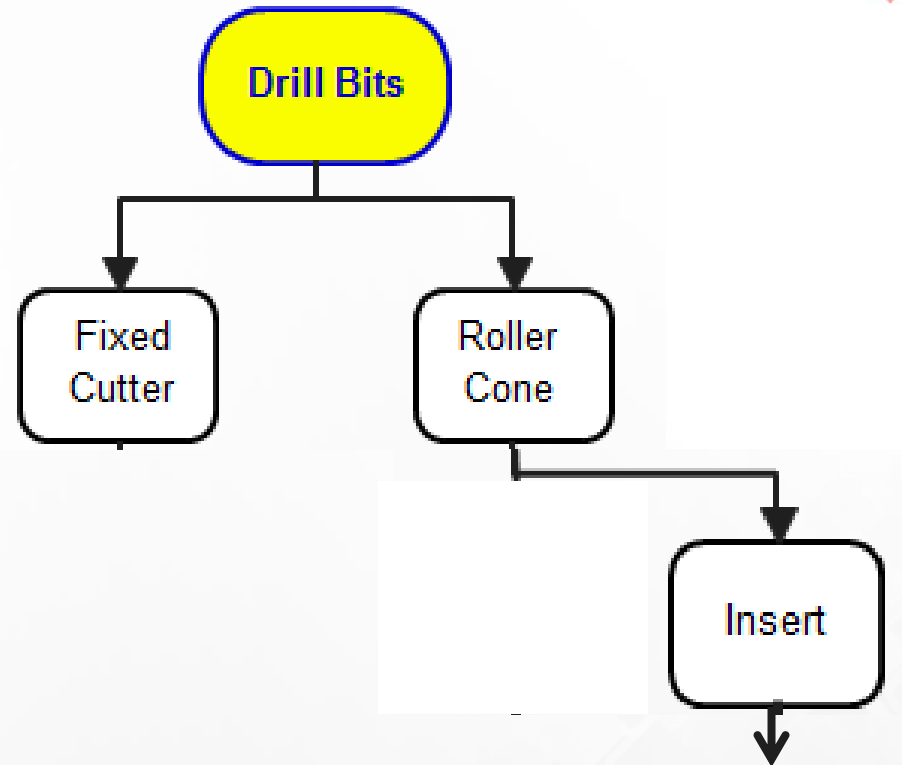

Bit Selection

Main considerations are the expected rate of penetration and formation strength/ hardness (Compressive Strength)

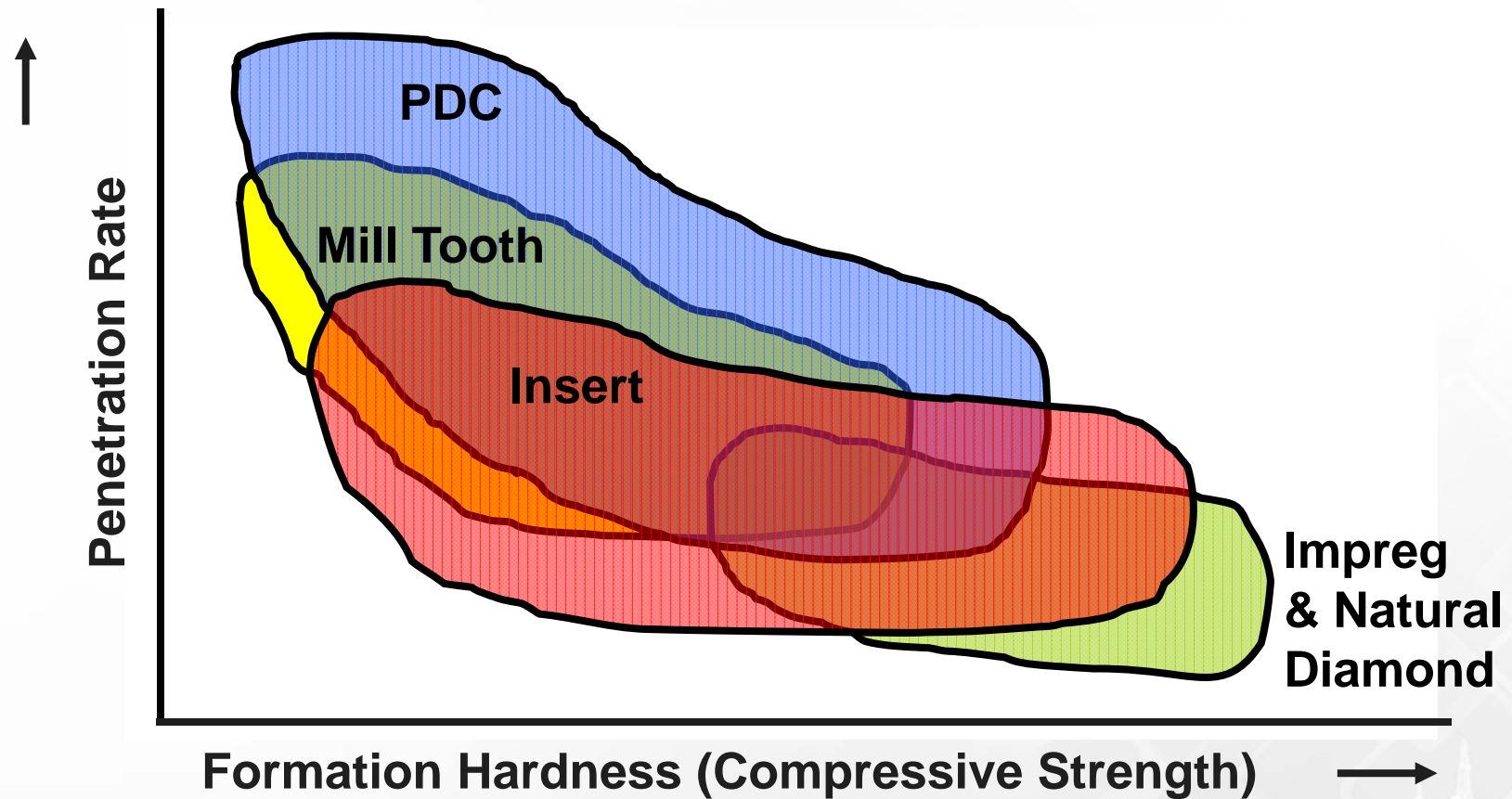

Roller Cone Bits Are Versatile

- **Bits can drill a variety of formations**
- **Bits can drill variable and interbedded formations**
- **Bits can survive intervals (soft-hard; hard-soft)**
- **Weight on bit and & RPM are easily adjusted**

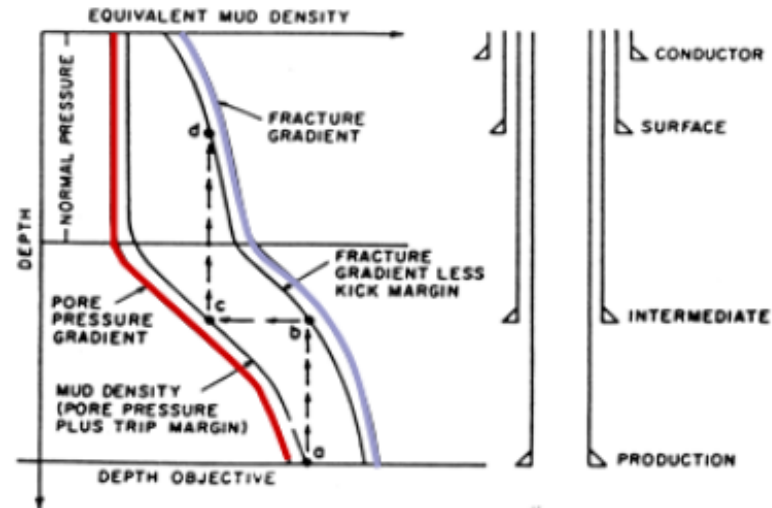

Considerations

- Well data
- Formation Characteristics
 - ✓ Pressure & strength
- Wireline logs
- Measurements while drilling
- Logging while drilling
- Casing points
- Casing design
- Well Test (if required)

Typical Well Sequence

- Drill to required depth
- Trip the drill string
- Run casing or liner
- Cement & test for integrity
- Repeat sequence for each hole or section
- Each hole or section may take one or several bits, depending on formation hardness

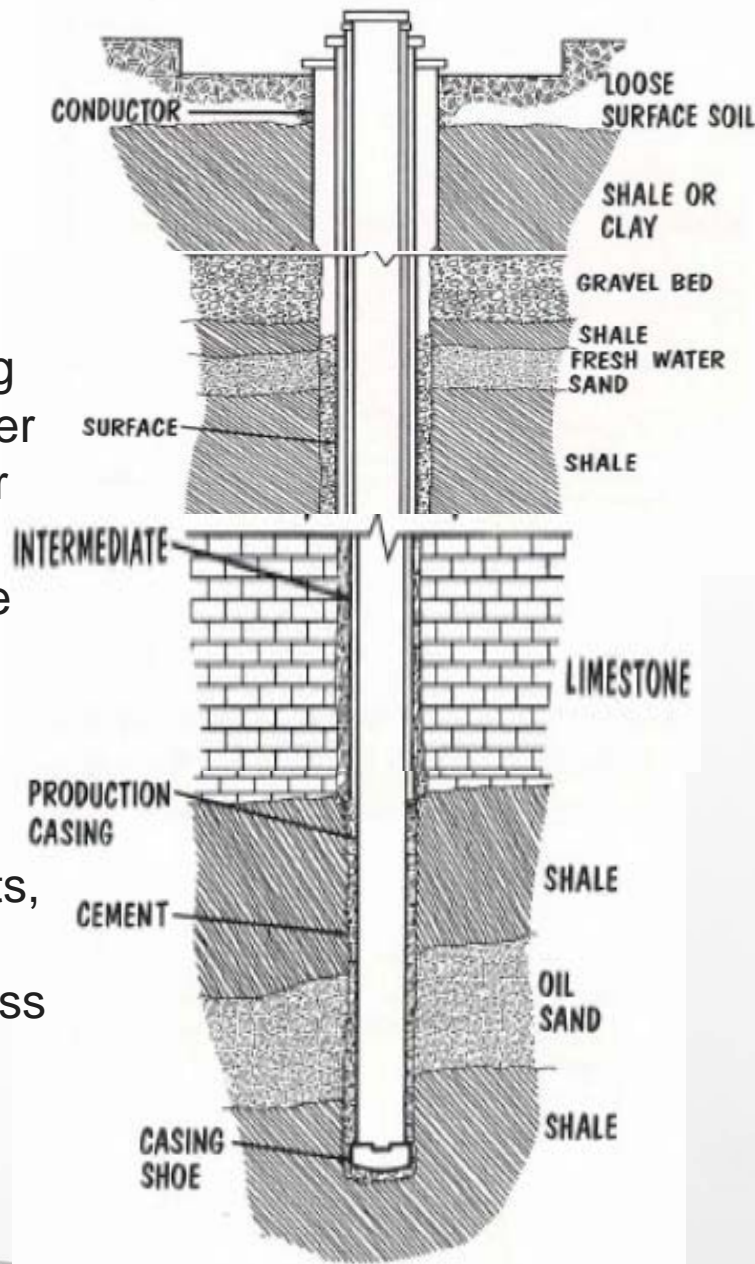

Conductor Pipe

Prevents hole collapsing
Guide drill bit & BHA

Surface Hole & casing

Protects fresh water aquifer
Provide support for the BOP's

Intermediate Hole & casing

Isolate formations which have different pore pressures
Ensure higher integrity at the casing shoe for deeper drilling with higher mud weights

Production Hole & casing

Drill to final depth and through producing intervals
Isolate oil and gas zones for perforating, completion, stimulation and production



So,..... Do you want to be a Drilling Engineer?

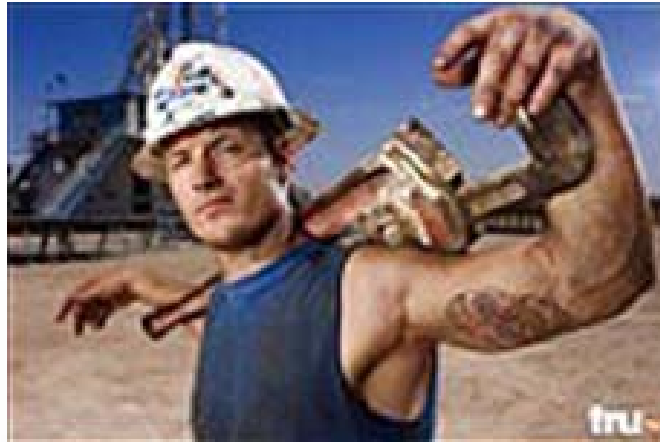



So,..... Do you want to be a Drilling Engineer?

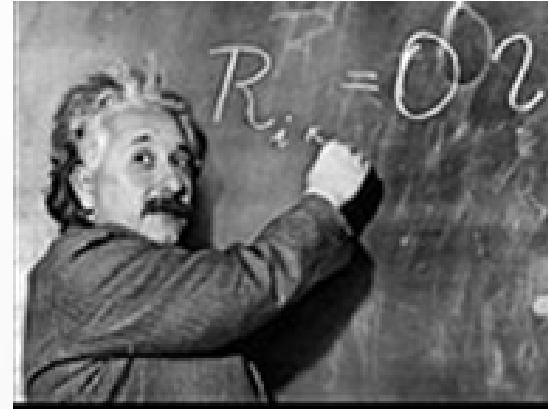

So,..... Do you want to be a Drilling Engineer?





So,..... Do you want to be a Drilling Engineer?

