

HEAT EXCHANGERS

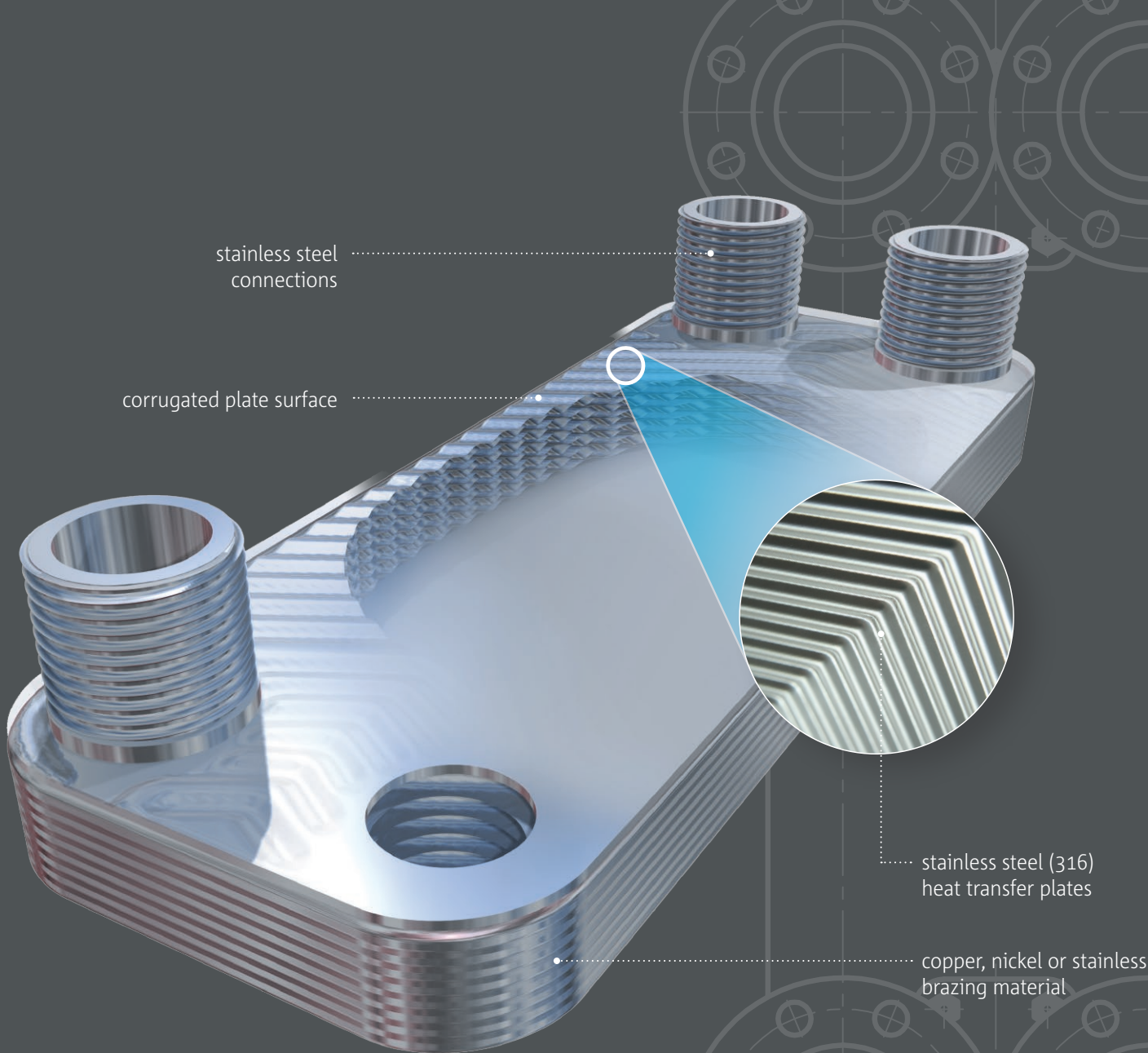

LINE

Brazed Plate
Heat Exchangers



stainless steel
connections

corrugated plate surface

stainless steel (316)
heat transfer plates

copper, nickel or stainless
brazing material

Advantages

- Compact models with high heat transfer capacity
- Stainless steel plates with corrugated surface ensure turbulent flow and structural support to the unit
- High heat transfer coefficient
- Cost efficiency
- Single or double wall option. Copper, nickel and stainless brazing material available
- Quick and easy installation

Applications

- Condensers and evaporators in refrigeration systems
- Oil coolers
- Close approach fluid-to-fluid heat transfer
- Industrial process heat recovery
- Solar and geothermic heating
- Hydronic heating
- Central heating
- Gas cooling

L LINE

Brazed Plate Heat Exchangers

Brazed plate heat exchangers consist of stainless steel plate packs, which have embossed chevron patterns. The plates are turned 180° to each other, causing the plate ridges to intersect, and creating a lattice of intersecting channels. The fluids can flow in counter-current or co-current way.

Special corrugation patterns promotes high turbulence flow. Turbulence dramatically improves heat transfer rates and reduces the amount of deposits inside the unit.



Flow Chanel Diagram in Heat Exchanger

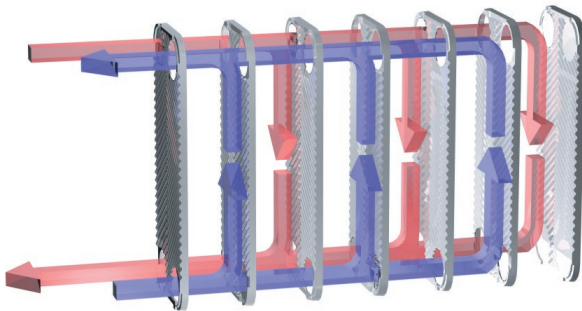

one-pass - channels are parallel.

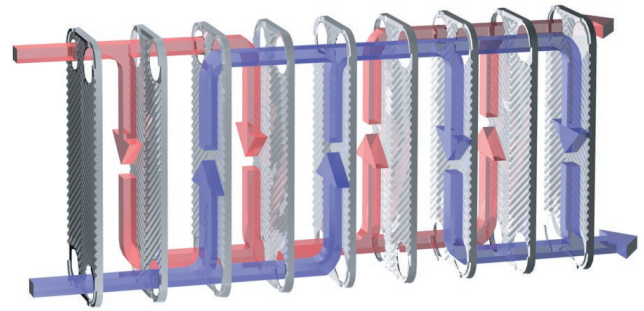

multi-pass - system of channels is divided into groups which are connected in series.

By changing number of plates, geometry of plates, pattern of plate corrugation and channel diagrams we can custom design heat exchangers for individual needs of the customers

Double Wall Brazed Plate Heat Exchangers

The design of the double wall brazed plate heat exchanger prevents cross contamination of fluid streams if there is an internal leak within the unit.

Two stainless steel plate walls separate the fluid streams, with an air gap in between. In the event of a leak, the affected fluid will flow into the air gap and escape out of the heat exchanger, enabling visual detection of the leak.

Advantages of AIC Double Wall Brazed Plate Heat Exchangers

- Visual leak detection
- Prevents fluid cross-contamination
- High thermal efficiency
- Compact design, small footprint

Applications

- Potable water heating
- Domestic hot water heating
- Hospitals
- Food and beverage processing
- Chemical industry

The entire construction is sealed together by means of brazing in a special vacuum furnace.

Flow Channel Diagram in Double Wall Heat Exchanger

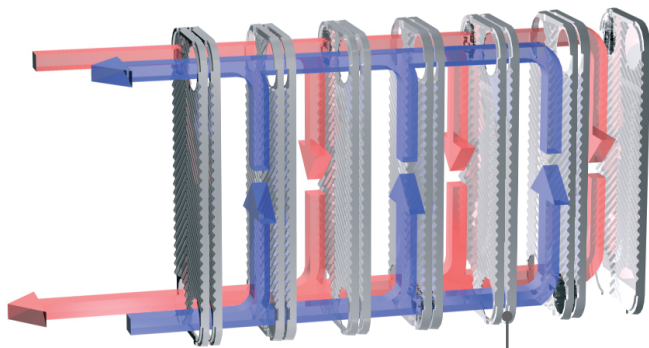

Double walls allow leaks to be visually detected without cross contaminating the fluid streams.

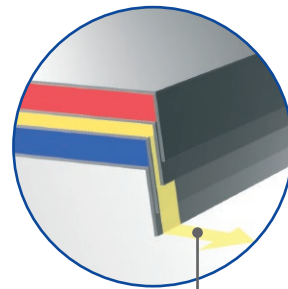

Leaks escape into the atmosphere through the air gap between the double walls.

L Line

Model	Dimensions mm (in)					Plate Area m ² (sq.ft)	Channel Volume L (USGal)	Maximum Flow L/min (GPM)	Max. Number of Plates	Weight (empty) kg (lb)
	A	B	C	D	F					
LA 14	194 (7.6)	80 (3.1)	154 (6.1)	40 (1.6)	10.0+2.3NP(0.39+0.09NP)	0.012 (0.13)	0.021 (0.005)	110 (29)	60	0.8+0.05NP(1.8+0.10NP)
LA 22	300 (11.8)	79 (3.1)	260 (10.2)	42 (1.7)	9.0+2.3NP(0.36+0.09NP)	0.022 (0.24)	0.034 (0.009)	68 (18)	60	1.1+0.09NP(2.4+0.20NP)
LA 34	469 (18.5)	80 (3.1)	432 (17.0)	42 (1.7)	9.0+2.3NP(0.36+0.09NP)	0.034 (0.37)	0.054 (0.014)	68 (18)	60	1.7+0.12NP(3.7+0.26NP)
LB 31	306 (12.0)	126 (5.0)	250 (9.8)	70 (2.8)	10+2.5NP (0.39+0.10NP)	0.032 (0.34)	0.054 (0.014)	212 (56)	150	1.6+0.15NP(3.5+0.33NP)
LB 47	414 (16.3)	122 (4.8)	360 (14.2)	68 (2.7)	10+2.5NP (0.39+0.10NP)	0.047 (0.51)	0.072 (0.019)	212 (56)	150	2.1+0.18NP(4.6+0.40NP)
LB 60	506 (19.9)	126 (5.0)	444 (17.5)	64 (2.5)	10+2.5NP (0.39+0.10NP)	0.058 (0.62)	0.097 (0.026)	212 (56)	150	3.5+0.24NP(7.7+0.53NP)
LC 110X	530 (20.9)	248 (9.8)	456 (17.9)	174 (6.9)	11.5+2.4NP(0.45+0.09NP)	0.113 (1.22)	0.196 (0.052)	450 (119)	200	7.2+0.52NP(15.8+1.14NP)
LC 110H	466 (18.3)	258(10.2)	378 (14.9)	170 (6.7)	10.0+2.4NP(0.39+0.09NP)	0.110 (1.18)	0.162 (0.043)	550 (145)	200	4.3+0.39NP(9.4+0.86NP)
LC 110L	463 (18.2)	255 (10.0)	378 (14.9)	170 (6.7)	10.0+2.4NP(0.39+0.09NP)	0.110 (1.18)	0.162 (0.043)	650 (172)	200	4.3+0.39NP(9.4+0.86NP)
LC 110Y	523 (20.6)	241 (9.5)	430 (16.9)	148 (5.8)	13.4+2.8NP(0.53+0.11NP)	0.104 (1.12)	0.216 (0.057)	700 (185)	200	7.2+0.55NP(15.8+1.21NP)
LC 110Z	523 (20.6)	241 (9.5)	430 (16.9)	148 (5.8)	13.4+2.8NP(0.53+0.11NP)	0.104 (1.12)	0.216 (0.057)	900 (238)	200	7.7+0.55NP (16.9+1.21NP)
LC 170	685 (27.0)	258 (10.2)	600 (23.6)	170 (6.7)	10.0+2.4NP(0.39+0.09NP)	0.170 (1.83)	0.255 (0.067)	500(132)	200	5.9+0.60NP(13.0+1.32NP)
LD 235	784 (30.9)	306 (12.0)	682 (26.9)	204 (8.0)	12.0+2.6NP(0.47+0.10NP)	0.235 (2.53)	0.398 (0.105)	1500 (396)	280	19.0+0.81NP(41.8+1.78NP)
LE 400	1008 (39.7)	387 (15.2)	861 (33.9)	240 (9.4)	17+2.75NP(0.67+0.11NP)	0.4 (4.31)	0.82 (0.217)	2500 (660)	400	74.3+1.63NP(163.8+3.59NP)

NP - number of plates

Standard Construction:

- Plates & Connections: AISI 316
- Brazing Material: Copper (Optional - Nickel, Stainless)
- Single Wall Plates (Optional - Double-Wall)

Design Parameters:

- Working Temperature up to 230°C (445°F)
- Working Pressure up to 45 bar (650 PSI)



DW Line

Model	Dimensions mm (in)					Plate Area m ² (sq.ft)	Channel Volume L (USGal)	Maximum Flow L/min (GPM)	Max. Number of Plates	Weight (empty) kg (lb)
	A	B	C	D	F					
LA 14DW	201 (7.9)	80 (3.1)	164 (6.5)	42 (1.7)	10+2.4NP (0.39+0.09NP)	0.014 (0.15)	0.022 (0.006)	110 (29)	60	0.8+0.05NP (1.8+0.10NP)
LA 22DW	300 (11.8)	80 (3.1)	260 (10.2)	42 (1.7)	10+2.4NP (0.39+0.09NP)	0.022 (0.24)	0.035 (0.009)	68 (18)	60	1.1+0.08NP (2.4+0.18NP)
LA 34DW	469 (18.5)	80 (3.1)	432 (17.0)	42 (1.7)	10+2.4NP (0.39+0.09NP)	0.034 (0.37)	0.054 (0.014)	68 (18)	60	1.7+0.12NP (3.7+0.26NP)
LB 31DW	286 (11.3)	117 (4.6)	232 (9.1)	68 (2.7)	10+2.5NP (0.39+0.10NP)	0.031 (0.33)	0.047 (0.012)	212 (56)	150	1.9+0.12NP (4.2+0.26NP)
LB 47DW	414 (16.3)	117 (4.6)	360 (14.2)	68 (2.7)	10+2.5NP (0.39+0.10NP)	0.047 (0.51)	0.072 (0.019)	212 (56)	150	2.3+0.19NP (5.1+0.42NP)
LB 60DW	534 (21.0)	117 (4.6)	480 (18.9)	68 (2.7)	10+2.5NP (0.39+0.10NP)	0.060 (0.65)	0.091 (0.024)	212 (56)	150	2.6+0.24NP (5.7+0.53NP)
LC 110DW	466 (18.3)	258 (10.2)	378 (14.9)	170 (6.7)	11+2.6NP (0.43+0.10NP)	0.110 (1.18)	0.162 (0.043)	550 (145)	200	8+0.61NP (17.637+1.34NP)
LC 170DW	685 (27.0)	258 (10.2)	600 (23.6)	170 (6.7)	11+2.6NP (0.43+0.10NP)	0.170 (1.83)	0.255 (0.067)	500 (132)	200	11+0.92NP (22+2.02NP)
LD 235DW	784 (30.9)	306 (12.0)	682 (26.9)	204 (8.0)	13+2.6NP (0.51+10NP)	0.235 (2.53)	0.398 (0.105)	1500 (396)	280	19.0+0.81NP (41.8+1.78NP)

NP - number of plates

Standard Construction

- Double Wall Plates
- Plate Material: ANSI 316
- Brazing Material: Copper

Design Parameters

- Working Temperature up to 230°C (445°F)
- Working Pressure up to 33.2 bar (481 PSI)

Standard Connections

Model		Solder	Threaded	Flanged
Standard	Double Wall	d* (in)	d (in)	d (in)
LA 14	LA 14DW	7/8"	3/4"	
LA 22	LA 22DW	7/8"	3/4"	
LA 34	LA 34DW	1-1/8"	1"	
LB 31	LB 31DW	1-1/8"	1"	
LB 47	LB 47DW	1-1/8"	1"	
LB 60	LB 60DW	1-1/8"	1"	
LC 110X	—	1-5/8", 2"	1-1/2", 2"	
LC 110H	LC 110DW	1-5/8"	2-1/2"	2" RF CL300
LC 110L	—	1-5/8"	2-1/2"	
LC 110Y	—	1-5/8"	2-1/2"	
LC 110Z	—	1-5/8"	3"	
LC 170	LC 170DW	1-5/8"	2-1/2"	2" RF CL300
LD 235	LD 235DW	2-1/8"	3"	3" RF CL300
LD 400	—	—	—	4" RF CL300

* inner diameter of connection

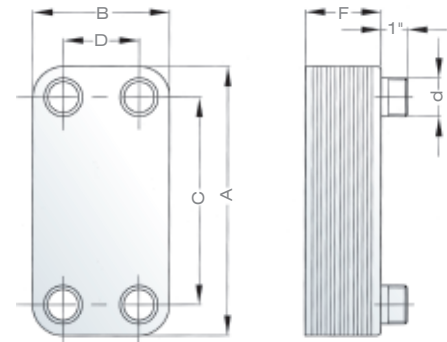

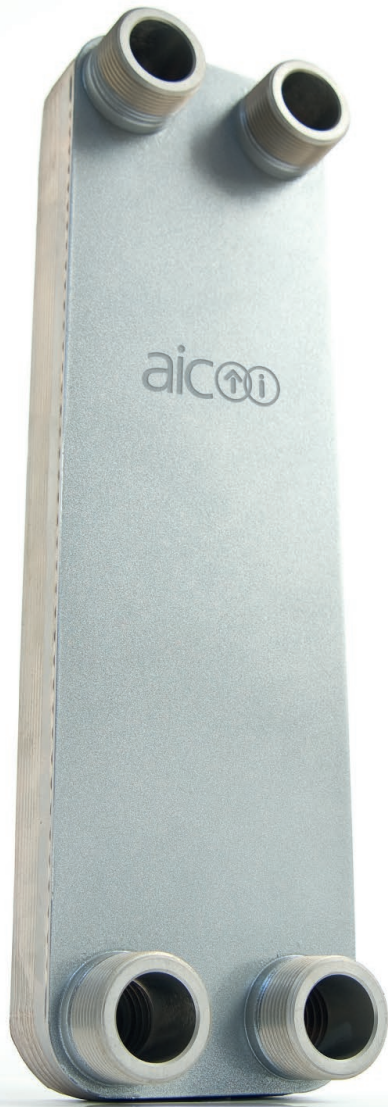

Quality Management System

At AIC we are committed to providing exceptional service and value to our diverse clientele.

Our stringent quality processes and management systems fulfill and are certified to the requirements of ISO9001.

Our products are certified by many national and international technical inspection authorities: Canadian CRN, UL, PED (97/23/EC), ASME UM and U. We can also work closely with our clients to design products to meet their exact criteria.



CRN



Advanced Industrial Components Inc. (AIC)
2899 Portland Drive
Oakville, ON L6H 5S4, Canada
☎ 905.829.4666
☎ 905.829.4646
TOLL-FREE: 1-888-738-1350
www.aicheatexchangers.com



_____ Authorized Representative _____